



07726-0379

# LEVEL 5

1 2 3 4 5



## VW T1 "GULF"

Beiliegenden Sicherheitstext beachten / Please note the enclosed safety advice

- ☞ Beiliegenden Sicherheitstext beachten und nachschlagsbereit halten
- ☞ Please note the enclosed safety advice and keep safe for later reference
- ☞ Respecter les consignes de sécurité ci-jointes et les conserver à portée de main
- ☞ Respectați textul de siguranță atașat și păstrați-l la îndemână
- ☞ Следвайте приложените текст за безопасност и го дръжте под ръка за справки
- ☞ Prilobena varnostna navodila izvajajte in jih hranite na vsem dostopnem mestu
- ☞ Διαβείτε υπόψη σας το συνημμένο κείμενο ασφαλείας και φυλάξτε το ώστε να ανατρέχετε σε αυτό όποτε χρειάζεται
- ☞ Ekteki guvenlik talimatlarını dikkate alıp, bakabileceğiniz bir şekilde muafaza ediniz
- ☞ Seguire le avvertenze di sicurezza allegate e tenerle a portata di mano
- ☞ Observez și sempre tener a dispoziție este text de siguranță adjuțit
- ☞ Ter em atenção o texto de segurança anexo e guardá-lo para consulta

- ☞ Overhold vedlagte sikkerhedsanvisninger og hav dem liggende i nærheden
- ☞ Ha alltid vedlagt sikkerhetstekst klar til bruk
- ☞ Beakta bifogad säkerhetstext och håll den i beredskap
- ☞ Huomioi ja säilytä oheiset varoitukset
- ☞ Соблюдайте технику безопасности, сохраняйте инструкцию для дальнейшего обращения
- ☞ Przestrzegaj załączonego tekstu dotyczącego bezpieczeństwa i mieć go zawsze pod ręką
- ☞ Dodržujte tento příložený bezpečnostní text a mějte ho po ruce
- ☞ A mellékelt biztonsági szöveget vegye figyelembe és tartsa fellepozásra készen

- ☞ Respektujte priložený bezpečnostný text a uchovajte ho pre budúce použitie
- ☞ Respectați textul de siguranță atașat și păstrați-l la îndemână
- ☞ Следвайте приложените текст за безопасност и го дръжте под ръка за справки
- ☞ Prilobena varnostna navodila izvajajte in jih hranite na vsem dostopnem mestu
- ☞ Διαβείτε υπόψη σας το συνημμένο κείμενο ασφαλείας και φυλάξτε το ώστε να ανατρέχετε σε αυτό όποτε χρειάζεται
- ☞ Ekteki guvenlik talimatlarını dikkate alıp, bakabileceğiniz bir şekilde muafaza ediniz

© 2024 Carrera Revell Europe GmbH, Henschelstr. 20-30, D-32257 Bünde.

REVELL is the registered trademark of Carrera Revell Europe GmbH, Germany. [www.revell.de](http://www.revell.de)





30% **04 M 50** 70%

- |  |   |  |
|--|---|--|
| 04 Weiß glänzend<br>04 White gloss<br>04 Blanc brillant<br>04 Bianco lucido<br>04 Bianco brillante<br>04 Bianco brillante<br>04 Hvid blank<br>04 Hvit glansende<br>04 Hvit blank<br>04 Valkoinen kiiltävä<br>04 Белый блестящий<br>04 Biały błyszczący<br>04 Біла ляска<br>04 Fehes, fényes<br>04 Biala laska<br>04 Alū stiklains<br>04 Balta stiklains<br>04 Biala stikla<br>04 Belyj usklyennyj<br>04 Belyj parlak | + | 50 Lichtblau glänzend<br>50 Light blue gloss<br>50 Bleu clair brillant<br>50 Lichtblau glänzend<br>50 Blu luce lucido<br>50 Azul claro brillante<br>50 Azul claro brillante<br>50 Lysvalk blank<br>50 Lysvalk glansende<br>50 Lysvalk blank<br>50 Valkoinen kiiltävä<br>50 Светло-синий блестящий<br>50 Rozświetlony niebieski błyszczący<br>50 Svetlo modra lasky<br>50 Kék világos, fényes<br>50 Svetlo modra lasky<br>50 Albasdudischi stiklains<br>50 Lysvalk glansende<br>50 Svetlo modra stikla<br>50 Belyj usklyennyj<br>50 Kék matt parlak |
|--|---|--|

731 **N**

- 05 Rot klar
- 05 Red clear
- 05 Rouge clair
- 05 Rood helder
- 05 Rosso chiaro
- 05 Rojo claro
- 05 Vermelho transparente
- 05 Rödbrun klar
- 05 Rödbrun klar
- 05 Punainen kirkas
- 05 Красный прозрачный
- 05 Czerwony przezroczysty
- 05 Červená bezbarvý
- 05 Piros, világos
- 05 Červená čirá
- 05 Rosu curat
- 05 Червено бистро
- 05 Rdeča čista
- 05 Коккоро идрарво
- 05 Kırmızı canlı

730 **O**

- 06 Orange klar
- 06 Orange clear
- 06 Orange clair
- 06 Orange helder
- 06 Arancio chiaro
- 06 Naranja clara
- 06 Laranja transparente
- 06 Orange klar
- 06 Oransje klar
- 06 Orange klar
- 06 Oranssi kirkas
- 06 Оранжевый прозрачный
- 06 Pomarańczowy przezroczysty
- 06 Oranžová bezbarvý
- 06 Narancs, világos
- 06 Oranžová čirá
- 06 Oranj curat
- 06 Оранжево бистро
- 06 Oranžna čista
- 06 Πορτοκαλί διάφανο
- 06 Turuncu canlı

50% **331 P 332** 50%

- |   |   |  |
|---|---|--|
| 331 Purpurno seidenmatt<br>331 Purple sat silk matt<br>331 Rouge soyeux satiné mat<br>331 Purpurmatt zijdemat<br>331 Rosso opaco opaco satinato<br>331 Rood gepolys mate satinato<br>331 Wermelbe purpura mate sedoso<br>331 Purpurmatt zijdemat<br>331 Purpurmatt zijdemat<br>331 Purpurmatt zijdemat<br>331 Purpurmatt zijdemat<br>331 Purpurmatt zijdemat<br>331 Purpurmatt zijdemat<br>331 Purpurmatt zijdemat<br>331 Purpurmatt zijdemat<br>331 Purpurmatt zijdemat<br>331 Purpurmatt zijdemat<br>331 Purpurmatt zijdemat<br>331 Purpurmatt zijdemat<br>331 Purpurmatt zijdemat<br>331 Purpurmatt zijdemat<br>331 Purpurmatt zijdemat<br>331 Purpurmatt zijdemat | + | 332 Hechtbraun seidenmatt<br>332 Wood brown silk matt<br>332 Brun bois satiné mat<br>332 Houtbruin zijdemat<br>332 Marrone legno opaco satinato<br>332 Woudbruine mate satinato<br>332 Castanho madeira mate sedoso<br>332 Hechtbraun seidenmatt<br>332 Hechtbraun seidenmatt<br>332 Hechtbraun seidenmatt<br>332 Hechtbraun seidenmatt<br>332 Hechtbraun seidenmatt<br>332 Hechtbraun seidenmatt<br>332 Hechtbraun seidenmatt<br>332 Hechtbraun seidenmatt<br>332 Hechtbraun seidenmatt<br>332 Hechtbraun seidenmatt<br>332 Hechtbraun seidenmatt<br>332 Hechtbraun seidenmatt<br>332 Hechtbraun seidenmatt<br>332 Hechtbraun seidenmatt<br>332 Hechtbraun seidenmatt<br>332 Hechtbraun seidenmatt<br>332 Hechtbraun seidenmatt<br>332 Hechtbraun seidenmatt<br>332 Hechtbraun seidenmatt |
|---|---|--|

50% **378 Q 302** 50%

- |   |   |   |
|---|---|---|
| 378 Dunkelgrau seidenmatt<br>378 Dark grey silk matt<br>378 Gris foncé satiné mat<br>378 Donkergruis zijdemat<br>378 Grigio scuro opaco satinato<br>378 Gris oscuro mate satinado<br>378 Cinza escuro mate sedoso<br>378 Dunkelgrau seidenmatt<br>378 Dunkelgrau seidenmatt<br>378 Dunkelgrau seidenmatt<br>378 Dunkelgrau seidenmatt<br>378 Dunkelgrau seidenmatt<br>378 Dunkelgrau seidenmatt<br>378 Dunkelgrau seidenmatt<br>378 Dunkelgrau seidenmatt<br>378 Dunkelgrau seidenmatt<br>378 Dunkelgrau seidenmatt<br>378 Dunkelgrau seidenmatt<br>378 Dunkelgrau seidenmatt<br>378 Dunkelgrau seidenmatt<br>378 Dunkelgrau seidenmatt<br>378 Dunkelgrau seidenmatt<br>378 Dunkelgrau seidenmatt<br>378 Dunkelgrau seidenmatt<br>378 Dunkelgrau seidenmatt | + | 302 Schwarz seidenmatt<br>302 Black silk matt<br>302 Noir satiné mat<br>302 Zwart zijdemat<br>302 Nero opaco satinato<br>302 Negro mate satinado<br>302 Preto mate sedoso<br>302 Schwarz seidenmatt<br>302 Schwarz seidenmatt<br>302 Schwarz seidenmatt<br>302 Schwarz seidenmatt<br>302 Schwarz seidenmatt<br>302 Schwarz seidenmatt<br>302 Schwarz seidenmatt<br>302 Schwarz seidenmatt<br>302 Schwarz seidenmatt<br>302 Schwarz seidenmatt<br>302 Schwarz seidenmatt<br>302 Schwarz seidenmatt<br>302 Schwarz seidenmatt<br>302 Schwarz seidenmatt<br>302 Schwarz seidenmatt<br>302 Schwarz seidenmatt<br>302 Schwarz seidenmatt<br>302 Schwarz seidenmatt |
|---|---|---|

01 **R**

- |   |   |   |   |
|---|---|---|---|
| 01 Rot klar<br>01 Red clear<br>01 Rouge clair<br>01 Rood helder<br>01 Rosso chiaro<br>01 Rojo claro<br>01 Vermelho transparente<br>01 Rödbrun klar<br>01 Rödbrun klar<br>01 Punainen kirkas<br>01 Красный прозрачный<br>01 Biały błyszczący<br>01 Біла ляска<br>01 Fehes, fényes<br>01 Biala laska<br>01 Alū stiklains<br>01 Balta stiklains<br>01 Biala stikla<br>01 Belyj usklyennyj<br>01 Belyj parlak | + | 02 Orange glänzend<br>02 Orange gloss<br>02 Orange brillant<br>02 Orange glänzend<br>02 Arancio lucido<br>02 Naranja brillante<br>02 Laranja brilhante<br>02 Klar blank<br>02 Orange glansende<br>02 Orange blank<br>02 Orange blank<br>02 Orange blank<br>02 Orange blank<br>02 Orange blank<br>02 Orange blank<br>02 Orange blank<br>02 Orange blank<br>02 Orange blank<br>02 Orange blank<br>02 Orange blank<br>02 Orange blank<br>02 Orange blank<br>02 Orange blank<br>02 Orange blank | 03 Feuerrot glänzend<br>03 Ferris red gloss<br>03 Rouge feu brillant<br>03 Vuoroadi glänzend<br>03 Rosso fuoco lucido<br>03 Rojo fuego brillante<br>03 Vermelho vivo brilhante<br>03 Röd klar<br>03 Röd glansende<br>03 Röd blank<br>03 Punainen kiiltävä<br>03 Красный блестящий<br>03 Pomarańczowy błyszczący<br>03 Oranžová leskly<br>03 Narancs, fényes<br>03 Oranžová leskly<br>03 Rosu aprins strilucitor<br>03 Червено блестящий<br>03 Rdeča sijača<br>03 Коккоро яркая блестящая<br>03 Kırmızı parlak |
|---|---|---|---|



- |  |  |
|--|--|
| Beispiel: mischen<br>Example: mixing<br>Exemple: mélangier<br>voorbeeld: mengen<br>Esempio: mescolare<br>Ejemplo: mezclar<br>Esempio: misturar<br>Eksempel: blandning<br>Eksempel: blandning<br>Eksempel: blanda<br>Esimerkki: sekoittaminen | Пример: смешивание<br>Przykład: mieszać<br>Príkład: mišani<br>Példa: keverés<br>Príkład: miešanie<br>Ejemplo: amestecare<br>Пример: смешивание<br>Пример: mešanje<br>Поробиття: авмішування<br>Örnek: karıştırma |
|--|--|

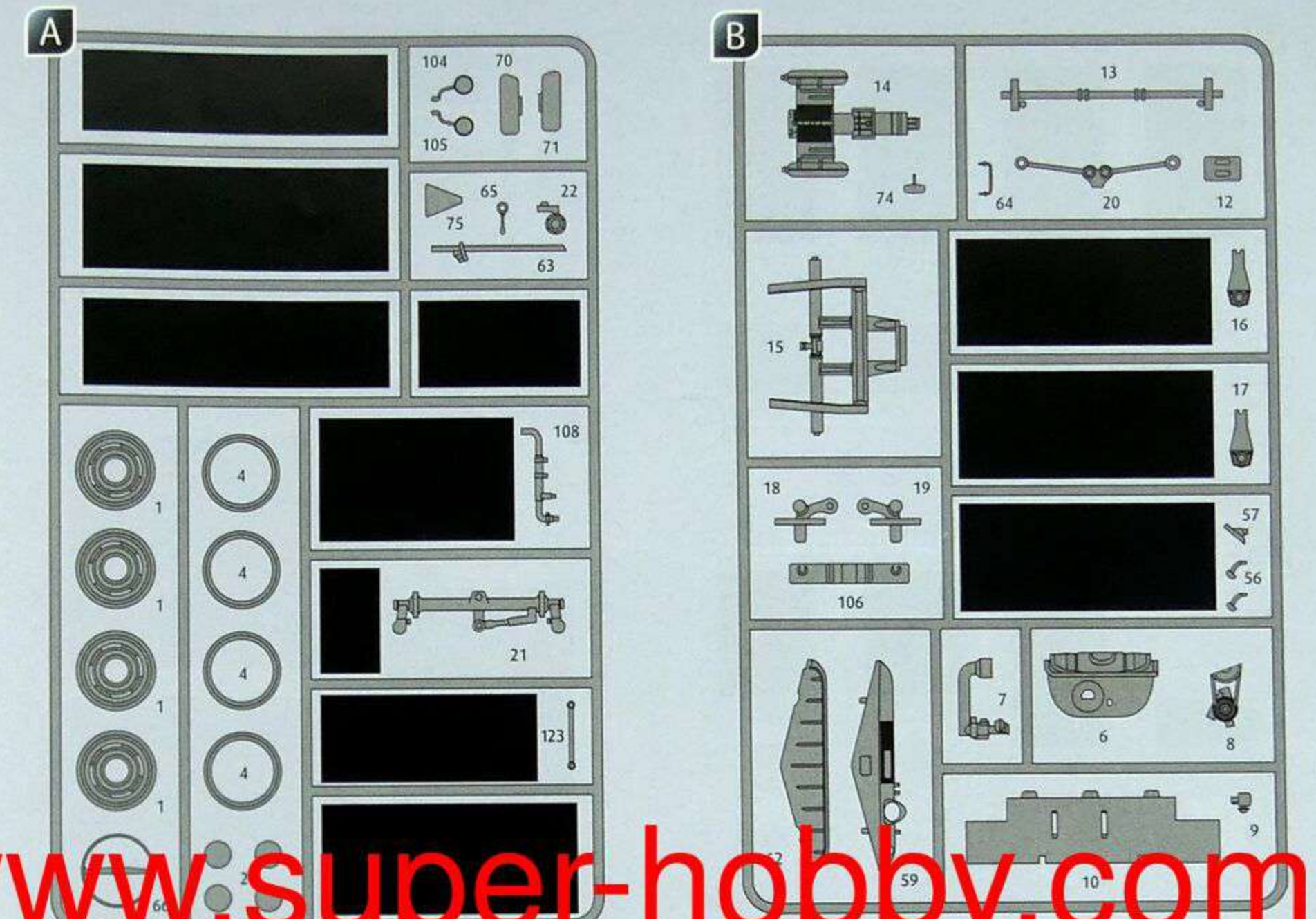

www.mojehobby.pl www.super-hobby.com

**46** Kundenservice: [www.revell-service.de](http://www.revell-service.de) oder Revell GmbH, Abteilung X, Henschelstr. 20-30, D-32257 Bünde (nur für DE, AT, NL, BE, LU, ES, IT, PL, US, CA). Für alle übrigen Länder kontaktieren Sie ausschließlich Ihren Händler oder Distributeur.

**47** Customer Service: [www.revell-service.de/en](http://www.revell-service.de/en) or Carrera Revell UK LTD, Unit 10, Old Airfield Industrial Estate, Cheddington Lane, Tring HP23 4QR, United Kingdom (only for United Kingdom and Ireland). For all other countries please contact your dealer or distributor only.

**48** Customer Service: [www.revell-service.de/en](http://www.revell-service.de/en) or Revell GmbH, Department X, Henschelstr. 20-30, 32257 Bünde, Germany (only for DE, AT, NL, BE, LU, ES, IT, PL, US, CA). For all other countries please contact your dealer or distributor only.

**49** Servicio al cliente: [www.revell-service.de](http://www.revell-service.de) o Revell GmbH, Abteilung X, Henschelstr. 20-30, D-32257 Bünde (sólo para DE, AT, NL, BE, LU, ES, IT, PL, US, CA). Para todos los demás países, por favor, póngase en contacto con su proveedor o distribuidor solamente.

**50** Servizio clienti: [www.revell-service.de](http://www.revell-service.de) o Revell GmbH, Abteilung X, Henschelstr. 20-30, D-32257 Bünde (solo per DE, AT, NL, BE, LU, ES, IT, PL, US, CA). Per tutti gli altri paesi si prega di contattare esclusivamente il proprio rivenditore o distributore.

**51** Serviço de apoio ao cliente: [www.revell-service.de](http://www.revell-service.de) ou Revell GmbH, Abteilung X, Henschelstr. 20-30, D-32257 Bünde (apenas para DE, AT, NL, BE, LU, ES, IT, PL, US, CA). Para todos os outros países, contacte apenas o seu revendedor ou distribuidor.

**52** Kundenservice: [www.revell-service.de](http://www.revell-service.de) eller Revell GmbH, Abteilung X, Henschelstr. 20-30, D-32257 Bünde (kun for DE, AT, NL, BE, LU, ES, IT, PL, US, CA). For alle øvrige lande bedes du udelukkende kontakte din forhandler eller distributor.

**53** Kundenservice: [www.revell-service.de](http://www.revell-service.de) eller Revell GmbH, Abteilung X, Henschelstr. 20-30, D-32257 Bünde (kun for DE, AT, NL, BE, LU, ES, IT, PL, US, CA). For alle andre land gjelder at all kontakt skal skje via din forhandler eller distributor.

**54** Kundtjänst: [www.revell-service.de](http://www.revell-service.de) eller Revell GmbH, Abteilung X, Henschelstr. 20-30, D-32257 Bünde (endast för DE, AT, NL, BE, LU, ES, IT, PL, US, CA). För övriga länder var god kontakta återförsäljaren eller distributören.

**55** Asiakaspalvelu: [www.revell-service.de](http://www.revell-service.de) tai Revell GmbH, Abteilung X, Henschelstr. 20-30, D-32257 Bünde (vain DE, AT, NL, BE, LU, ES, IT, PL, US, CA). Muiden maiden kohdalla ota yhteyttä paikalliseen jälleenmyyjään tai jakelijaan.

**56** Служба поддержки клиентов: [www.revell-service.de](http://www.revell-service.de) или Revell GmbH, Abteilung X, Henschelstr. 20-30, D-32257 Bünde (только для DE, AT, NL, BE, LU, ES, IT, PL, US, CA). Клиентам из других стран следует обращаться исключительно к своему поставщику или дистрибутору.

**57** Dział obsługi klienta: [www.revell-service.de](http://www.revell-service.de) lub Revell GmbH, Abteilung X, Henschelstr. 20-30, D-32257 Bünde (tylko dla DE, AT, NL, BE, LU, ES, IT, PL, US, CA). We wszystkich pozostałych krajach należy kontaktować się wyłącznie ze sprzedawcą lub dystrybutorem.

**58** Zákaznícký servis: [www.revell-service.de](http://www.revell-service.de) nebo Revell GmbH, Abteilung X, Henschelstr. 20-30, D-32257 Bünde (pouze pro DE, AT, NL, BE, LU, ES, IT, PL, US, CA). Pro všechny ostatní země kontaktujte výlučně svého obchodníka nebo prodejce.

**59** Ügyfélszolgálat: [www.revell-service.de](http://www.revell-service.de) vagy Revell GmbH, Abteilung X, Henschelstr. 20-30, D-32257 Bünde (csak DE, AT, NL, BE, LU, ES, IT, PL, US, CA országok esetében). Az egyéb országok esetének kizárólag kereskedőjével, vagy forgalmazójával vegye fel a kapcsolatot.

**60** Zákaznícký servis: [www.revell-service.de](http://www.revell-service.de) alebo Revell GmbH, Abteilung X, Henschelstr. 20-30, D-32257 Bünde (iba pre DE, AT, NL, BE, LU, ES, IT, PL, US, CA). Pre všetky ostatné krajiny kontaktujte výlučne svojho obchodníka alebo predajcu.

**61** Serviciul clienți: [www.revell-service.de](http://www.revell-service.de) sau Revell GmbH, Abteilung X, Henschelstr. 20-30, D-32257 Bünde (doar pentru DE, AT, NL, BE, LU, ES, IT, PL, US, CA). Pentru toate celelalte țări contactați doar comerciantul dvs. sau distribuitorul.

**62** Отдел за обслужване на клиенти: [www.revell-service.de](http://www.revell-service.de) или Revell GmbH, Abteilung X, Henschelstr. 20-30, D-32257 Bünde (само за DE, AT, NL, BE, LU, ES, IT, PL, US, CA). За все остале државе се обрните само на продавца или дистрибутера.

**63** Služba za pomoć strankam: [www.revell-service.de](http://www.revell-service.de) ali Revell GmbH, Abteilung X, Henschelstr. 20-30, D-32257 Bünde (samo za DE, AT, NL, BE, LU, ES, IT, PL, US, CA). Za vse ostale države se obrnite samo na prodajalca ali distributerja.

**64** Τμήμα εξυπηρέτησης πελατών: [www.revell-service.de](http://www.revell-service.de) ή Revell GmbH, Abteilung X, Henschelstr. 20-30, D-32257 Bünde (μόνο για DE, AT, NL, BE, LU, ES, IT, PL, US, CA). Για όλες τις άλλες χώρες επικοινωνήστε αποκλειστικά με τον έμπορο ή τον αντιπρόσωπο της περιοχής σας.

**65** Müsteri hizmetleri: [www.revell-service.de](http://www.revell-service.de) veya Revell GmbH, Abteilung X, Henschelstr. 20-30, D-32257 Bünde (sadece DE, AT, NL, BE, LU, ES, IT, PL, ABD, CA için). Tüm diğer ülkeler için sadece satıcınıza veya distribütörünüze başvurun.

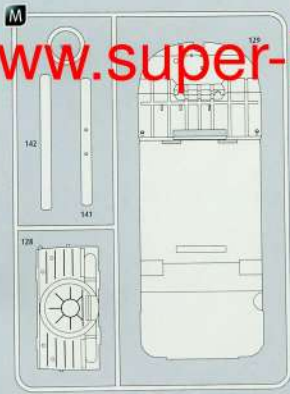
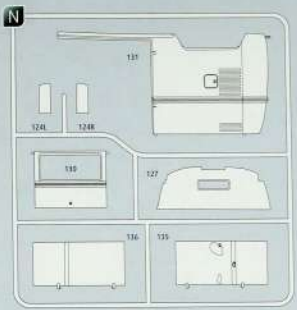
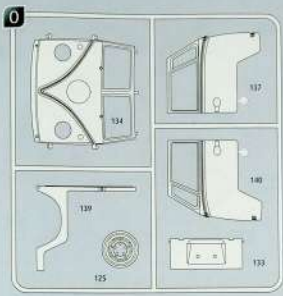
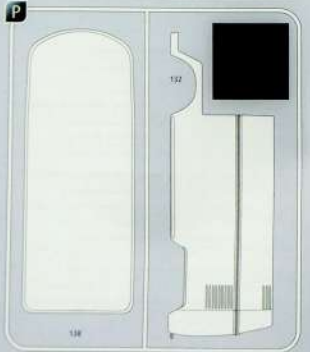
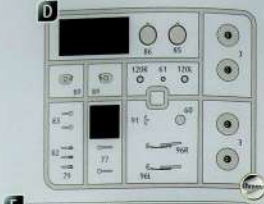
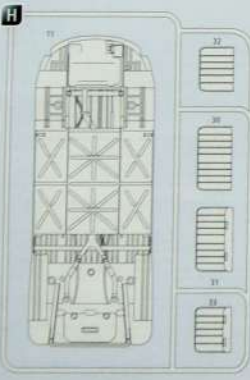

Fensterolie  
Window sheet

[www.mojehobby.pl](http://www.mojehobby.pl) [www.super-hobby.com](http://www.super-hobby.com)

- ⬛ Nicht beschriftete Teile  
Ⓜ Nicht mit schneiden
- Ⓜ Pieces non étiquetées  
Ⓜ Ne pas couper
- Ⓜ Teile ohne Beschriftung  
Ⓜ Nicht schneiden
- Ⓜ Pieces non étiquetées  
Ⓜ Ne pas couper
- Ⓜ Peças não rotuladas  
Ⓜ Não cortar
- Ⓜ Deler som ikke er mærket  
Ⓜ Ikke rive eller klip
- Ⓜ Не помеченные детали  
Ⓜ Не резать
- Ⓜ Partes não rotuladas  
Ⓜ Não cortar
- Ⓜ Helyzetbevitelt csatlakozások  
Ⓜ Csak a megfelelő helyre illeszthető
- Ⓜ Helyzetbevitelt csatlakozások  
Ⓜ Csak a megfelelő helyre illeszthető
- Ⓜ Helyzetbevitelt csatlakozások  
Ⓜ Csak a megfelelő helyre illeszthető
- Ⓜ Helyzetbevitelt csatlakozások  
Ⓜ Csak a megfelelő helyre illeszthető
- Ⓜ Helyzetbevitelt csatlakozások  
Ⓜ Csak a megfelelő helyre illeszthető
- Ⓜ Helyzetbevitelt csatlakozások  
Ⓜ Csak a megfelelő helyre illeszthető
- Ⓜ Helyzetbevitelt csatlakozások  
Ⓜ Csak a megfelelő helyre illeszthető

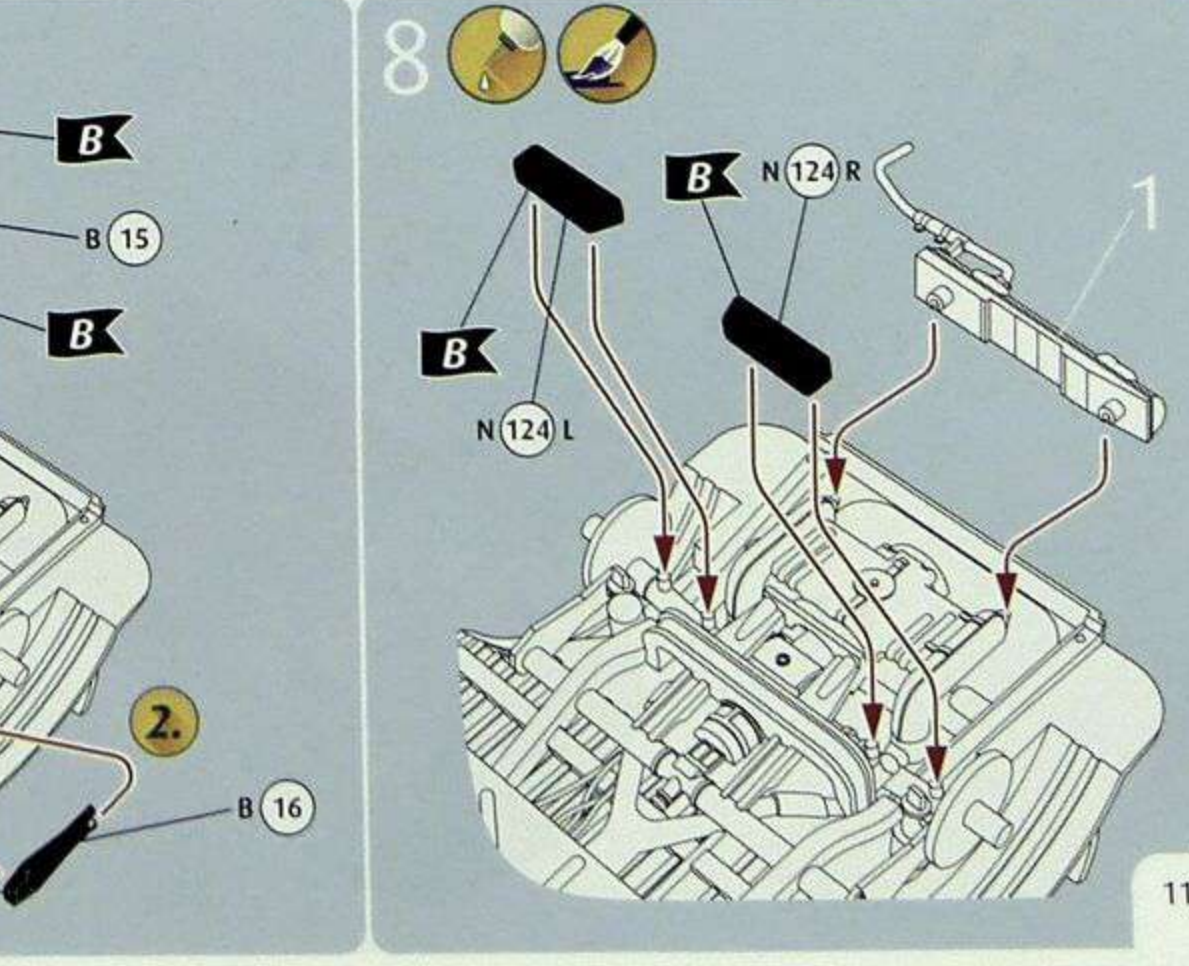
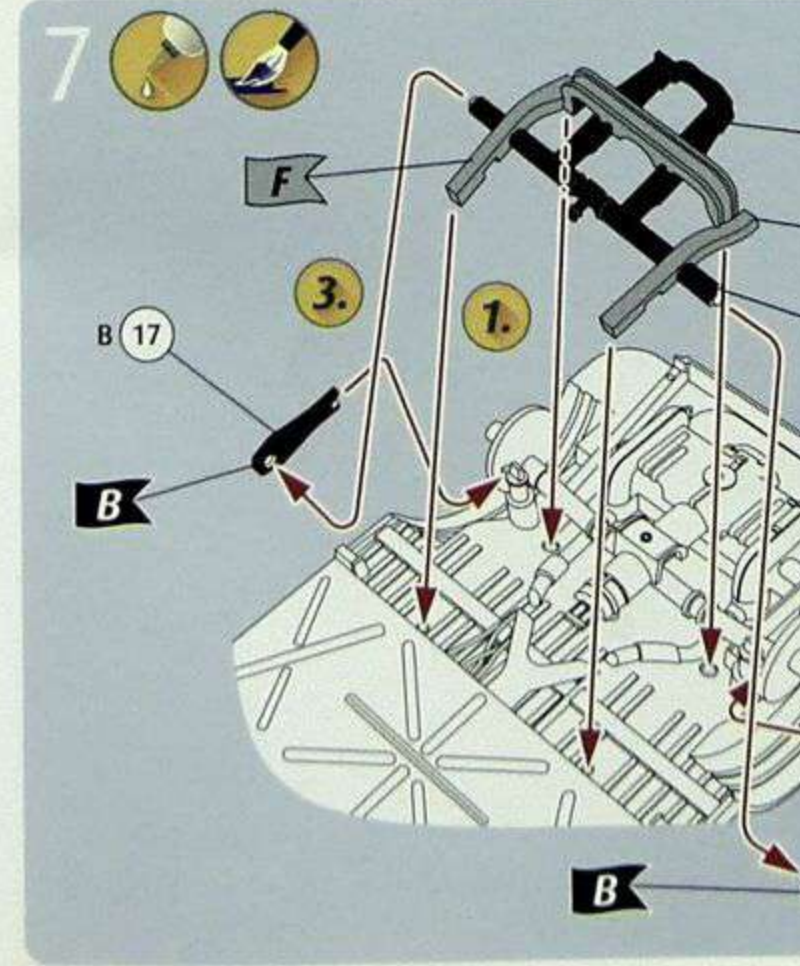
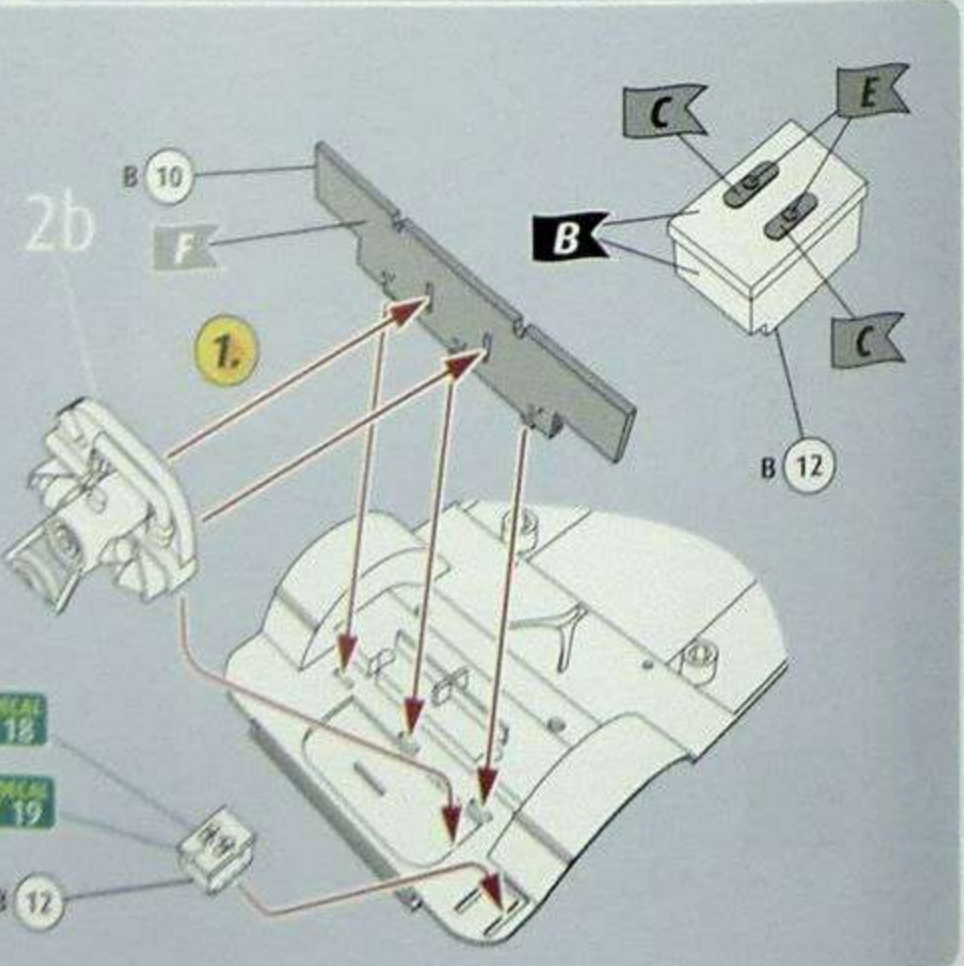
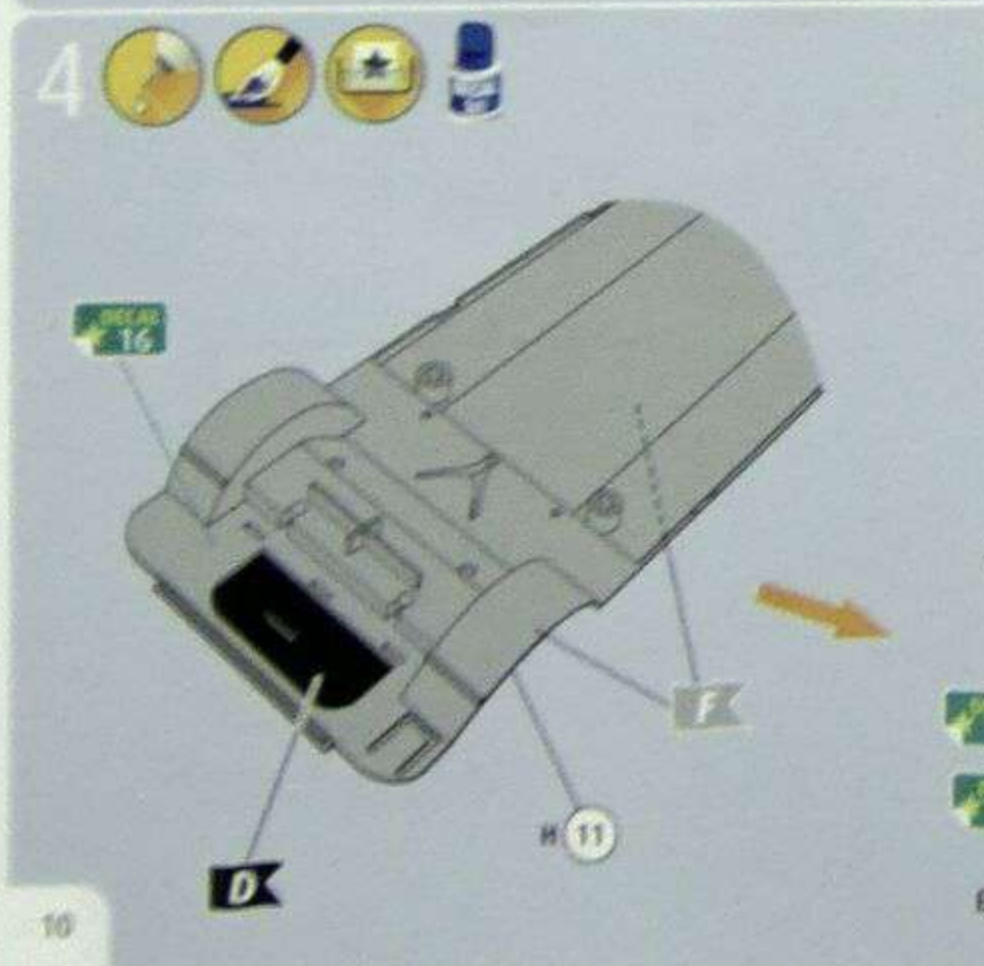
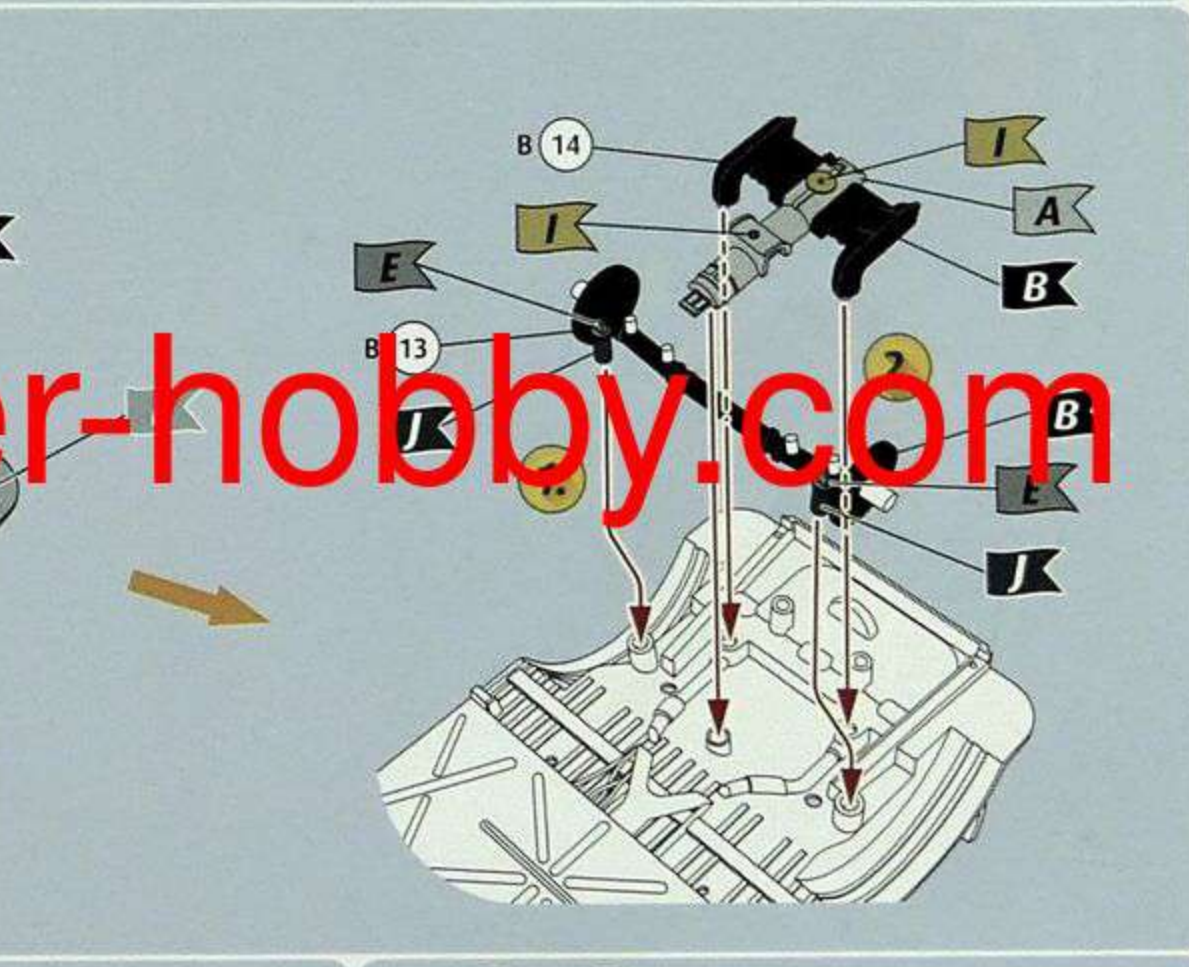
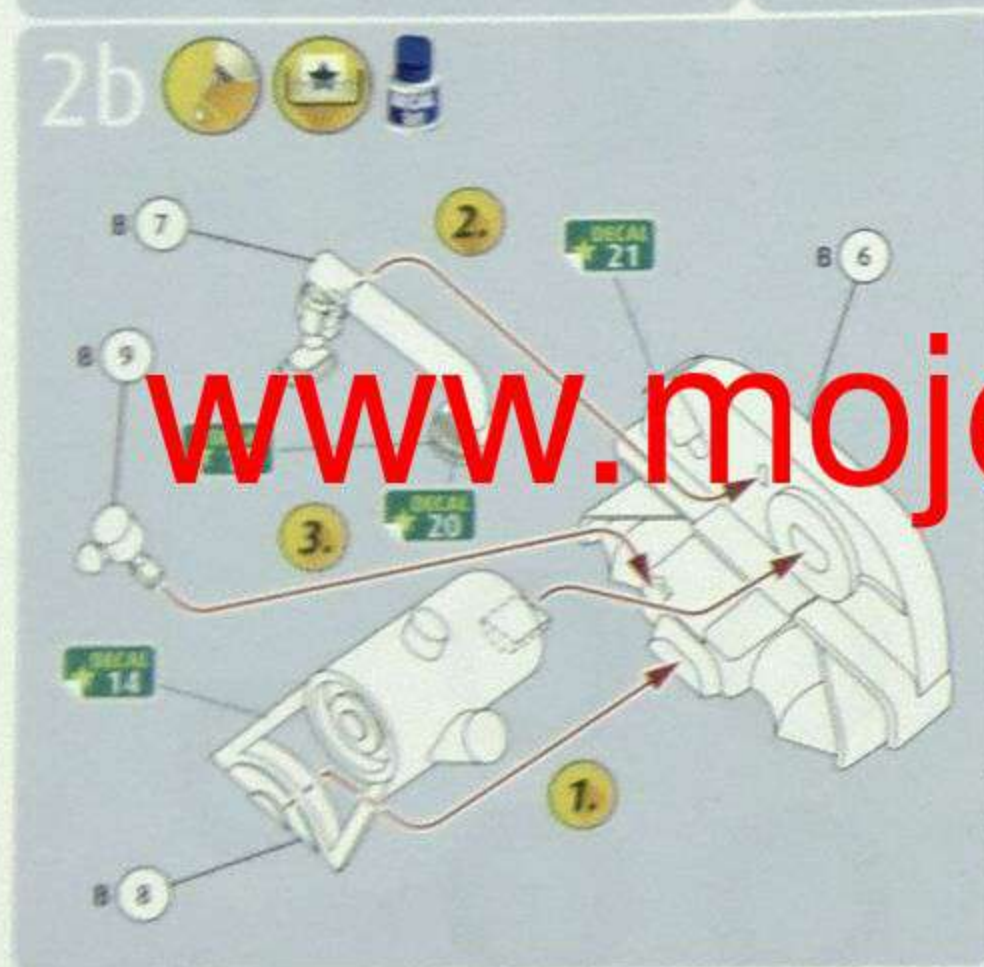
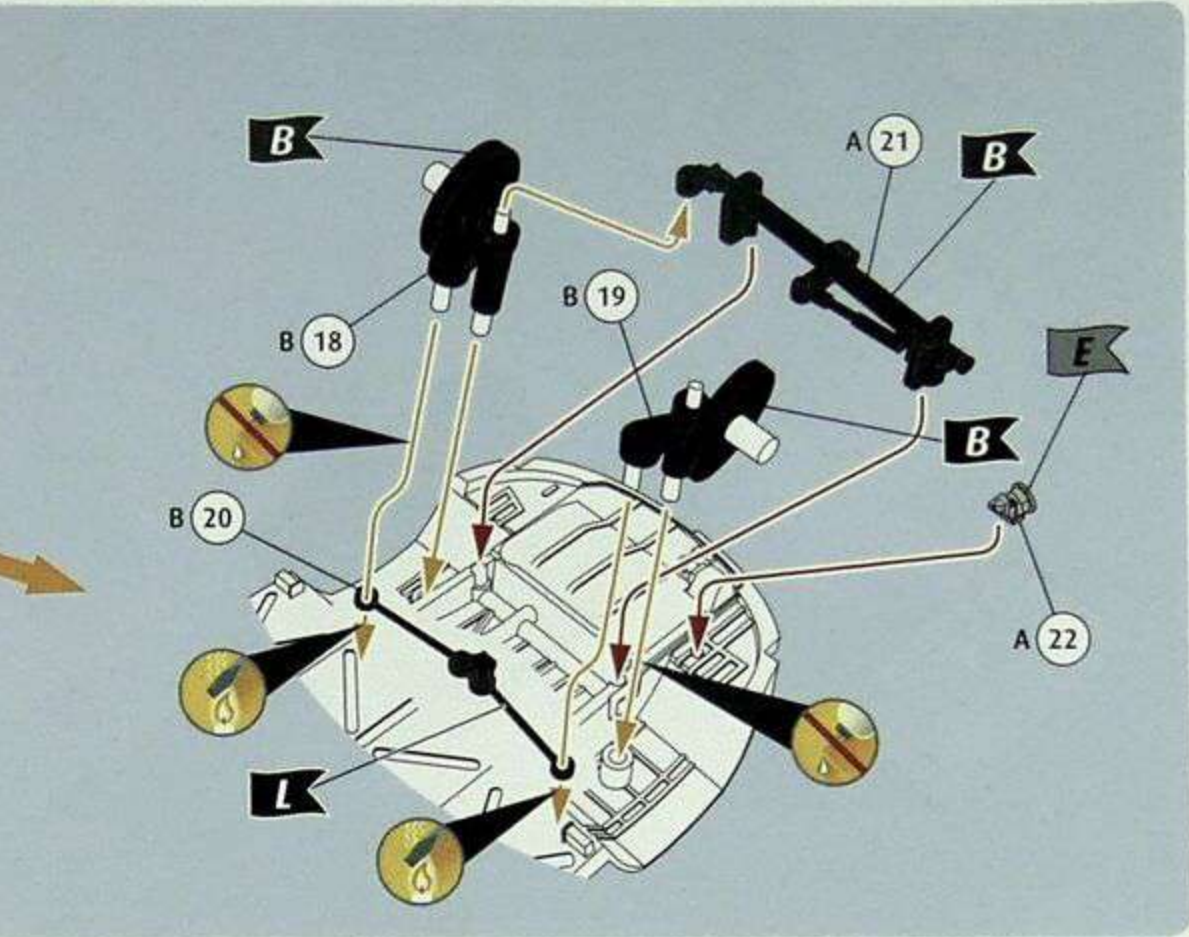
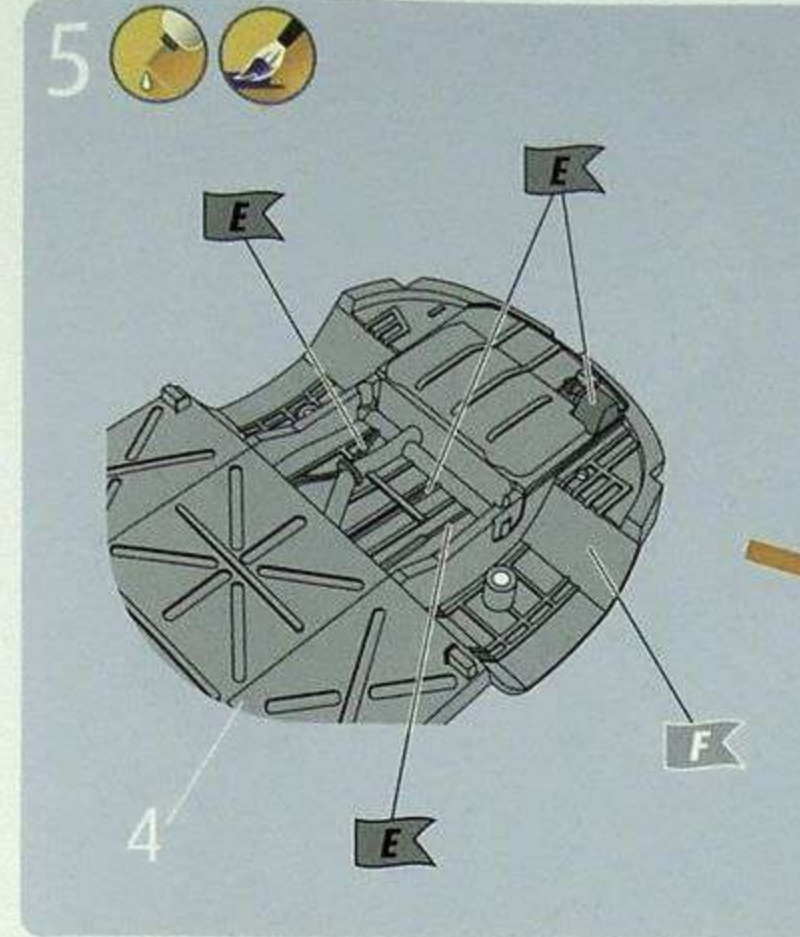
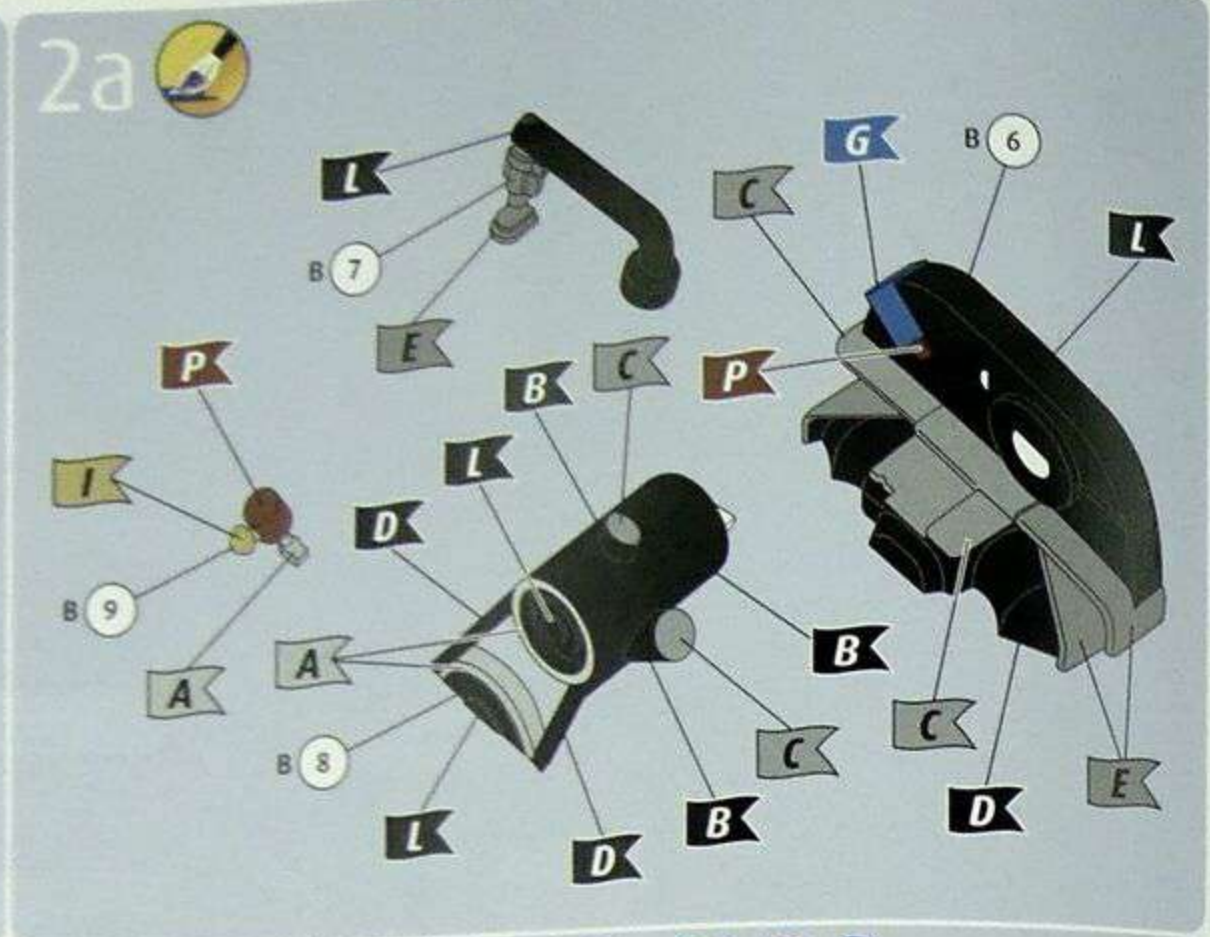
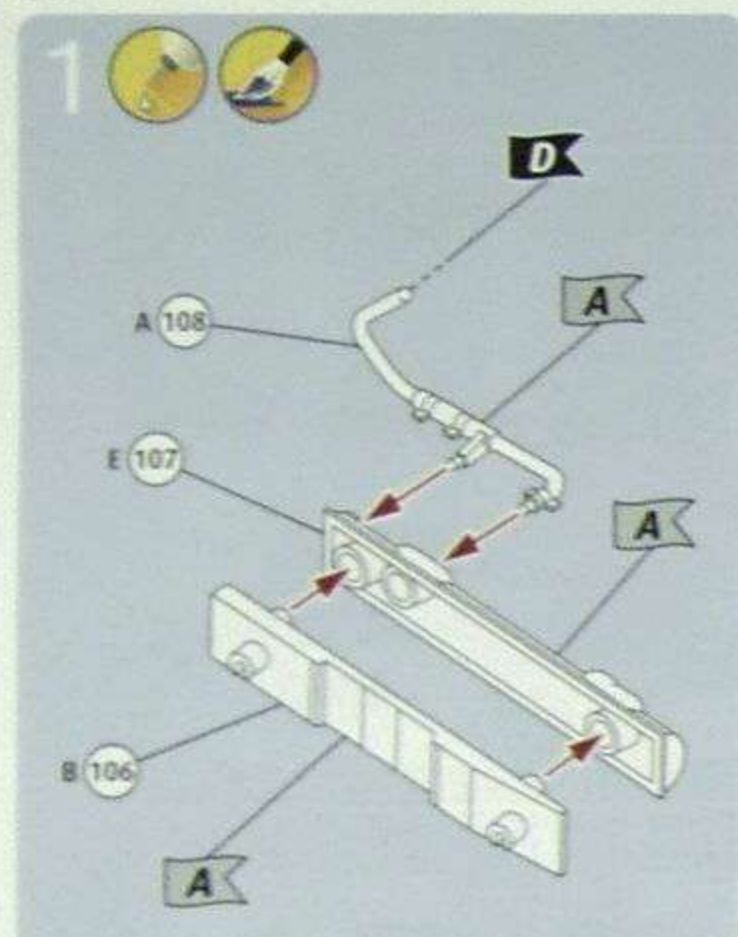

[www.moje hobby.pl](http://www.moje hobby.pl) [www.super-hobby.com](http://www.super-hobby.com)

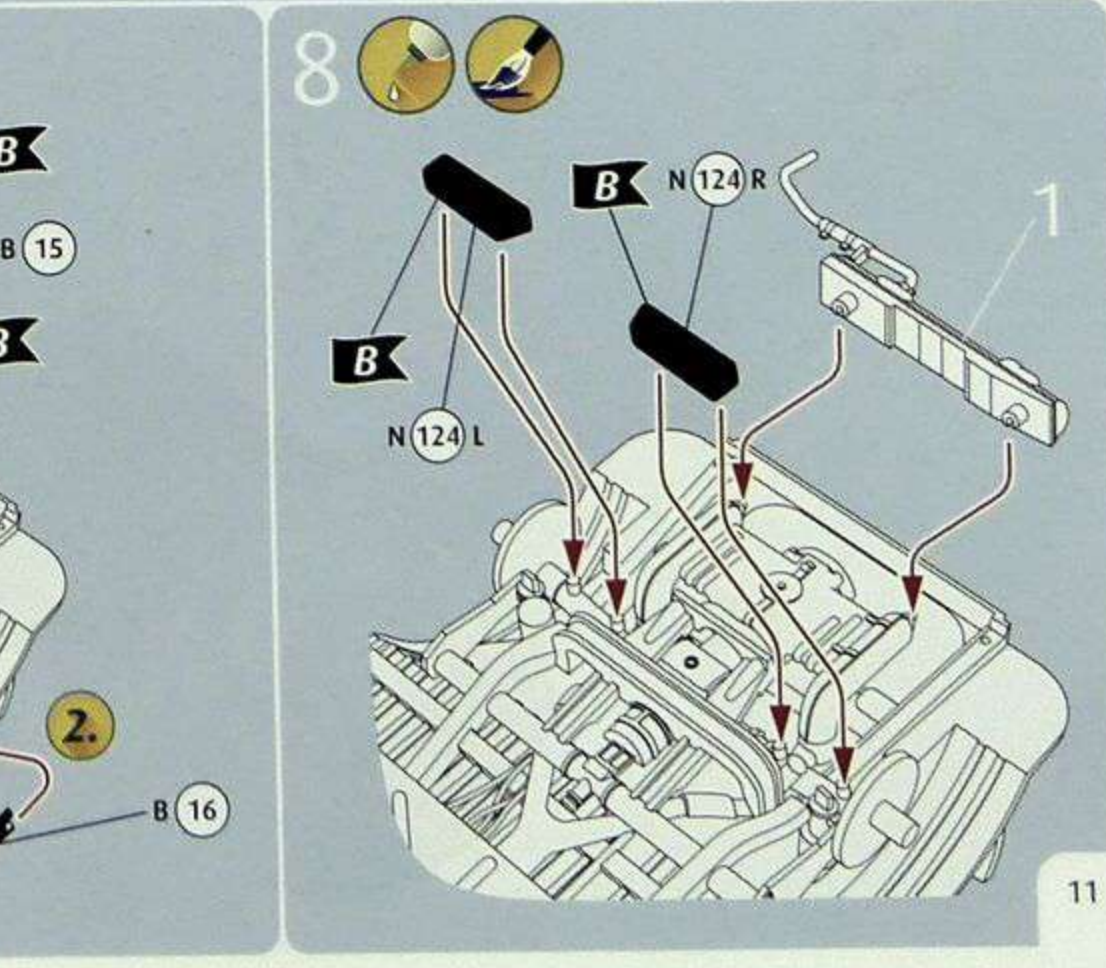
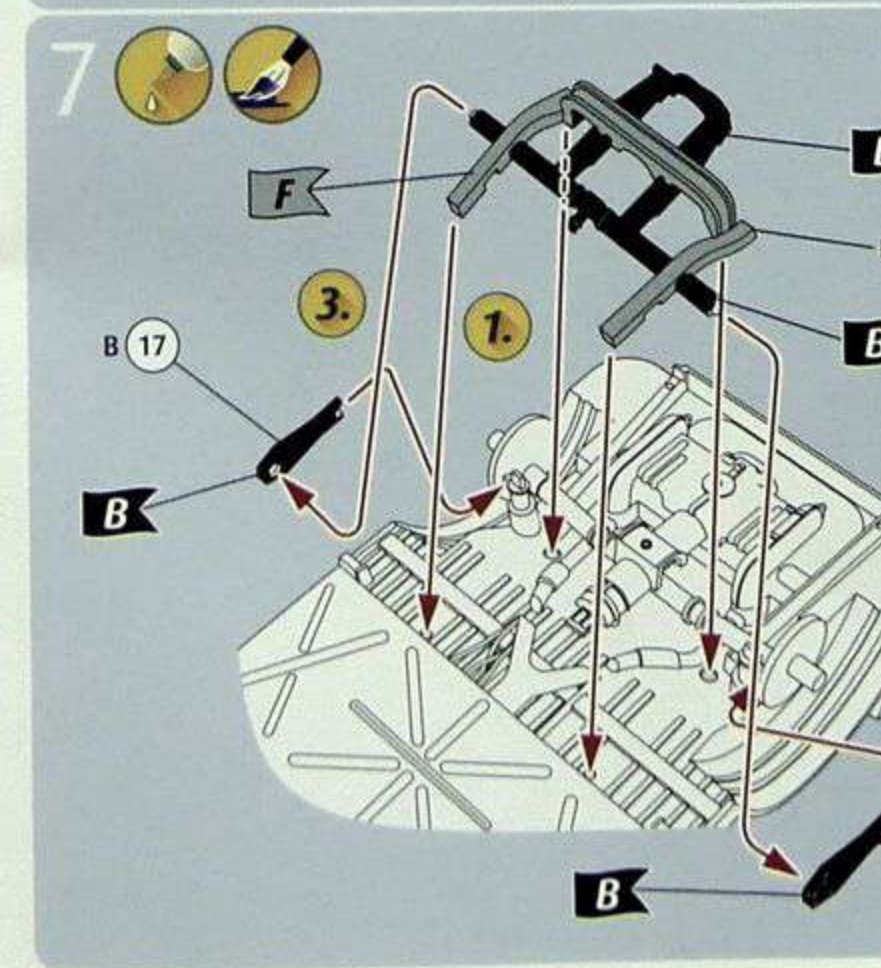
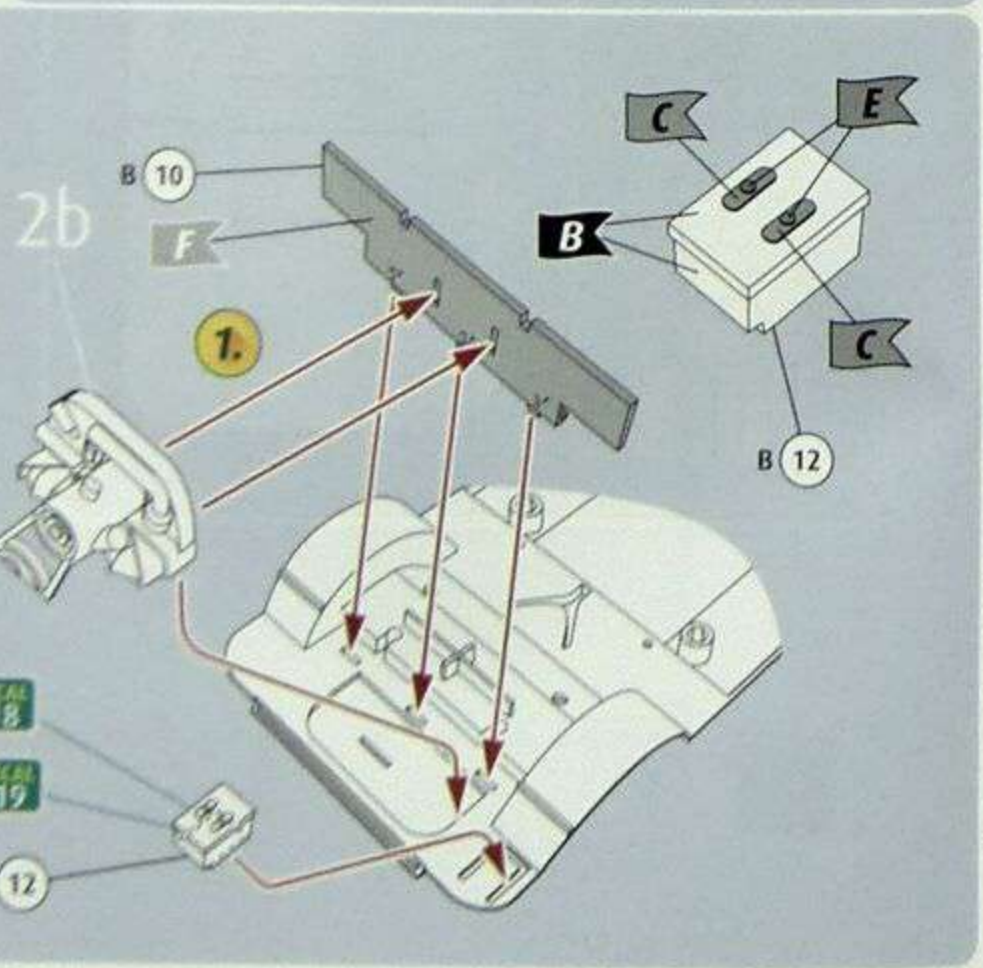
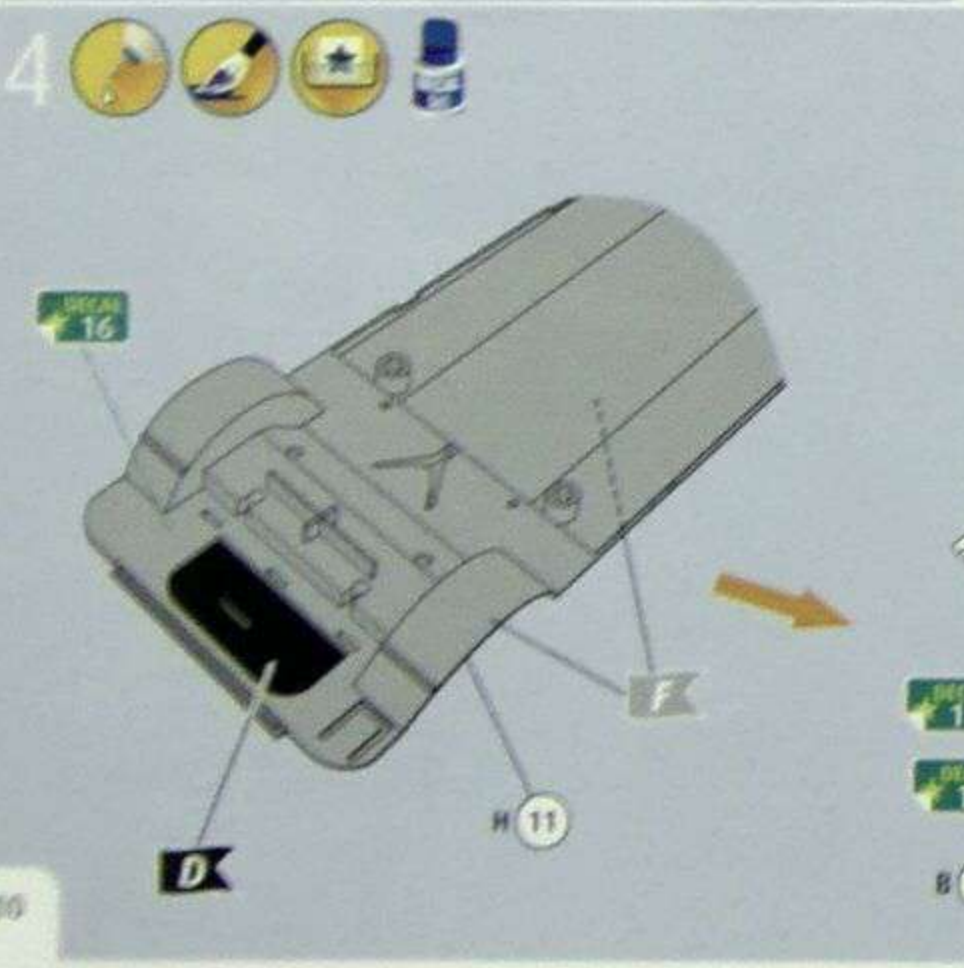
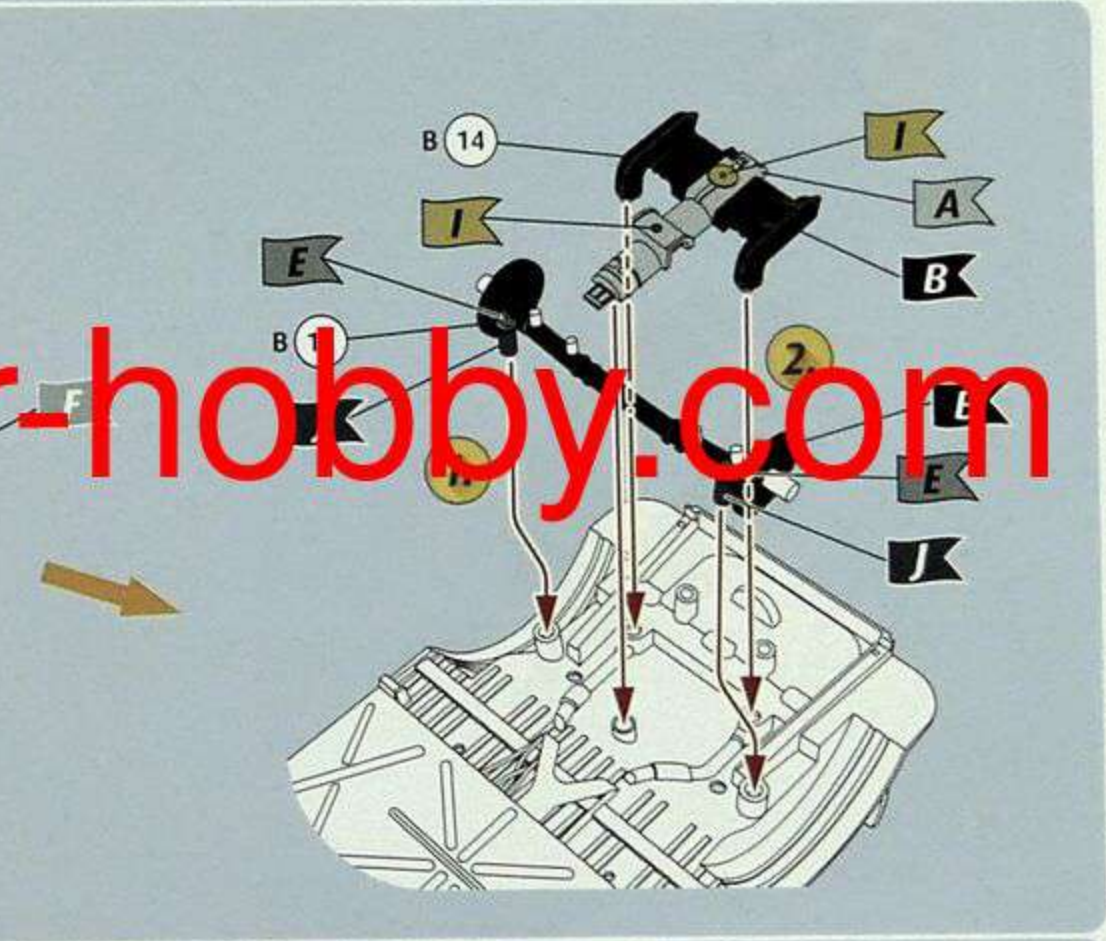
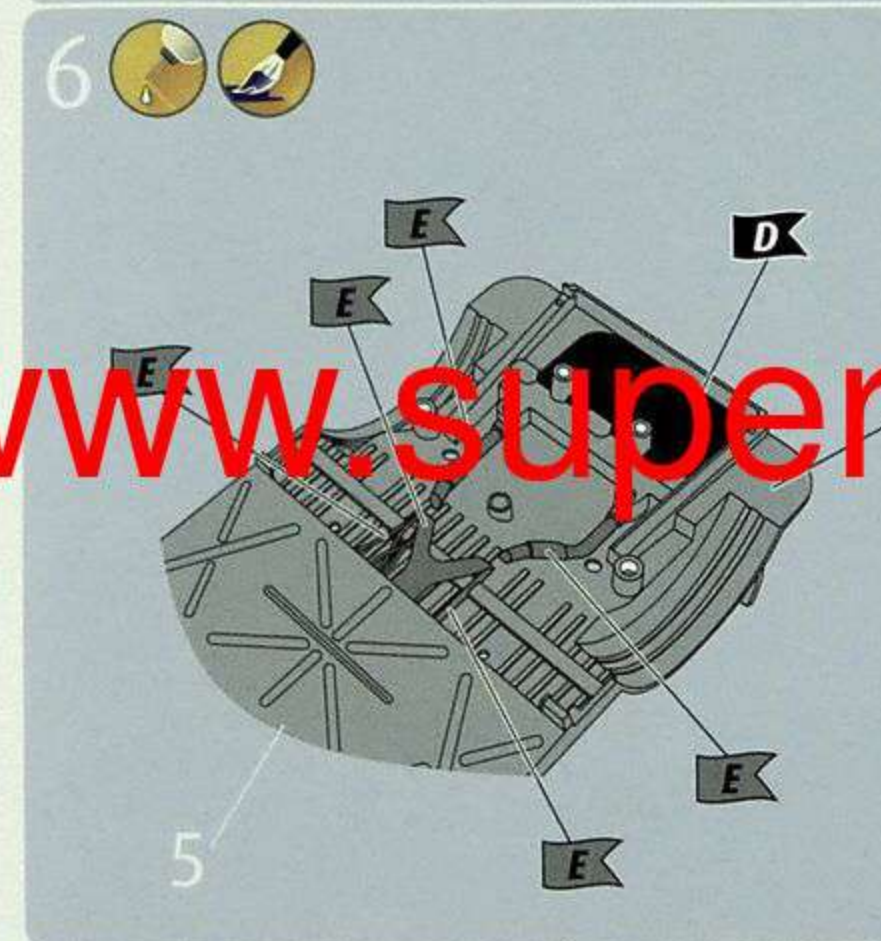
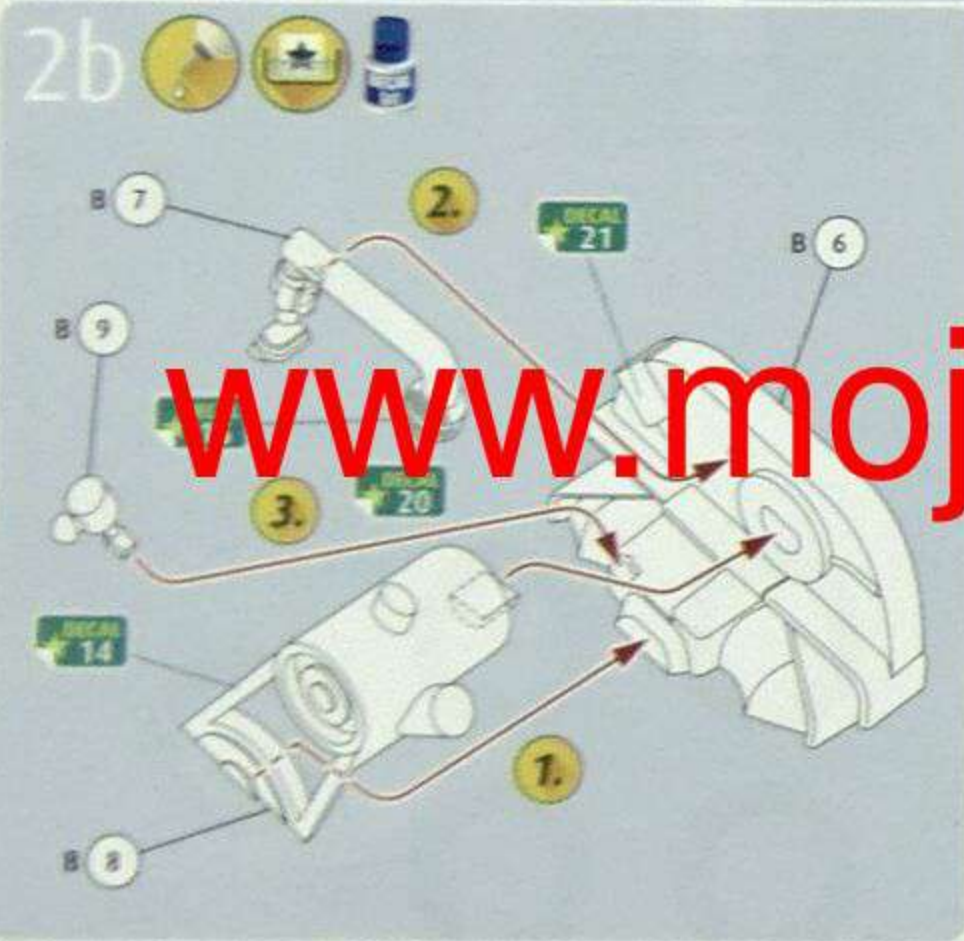
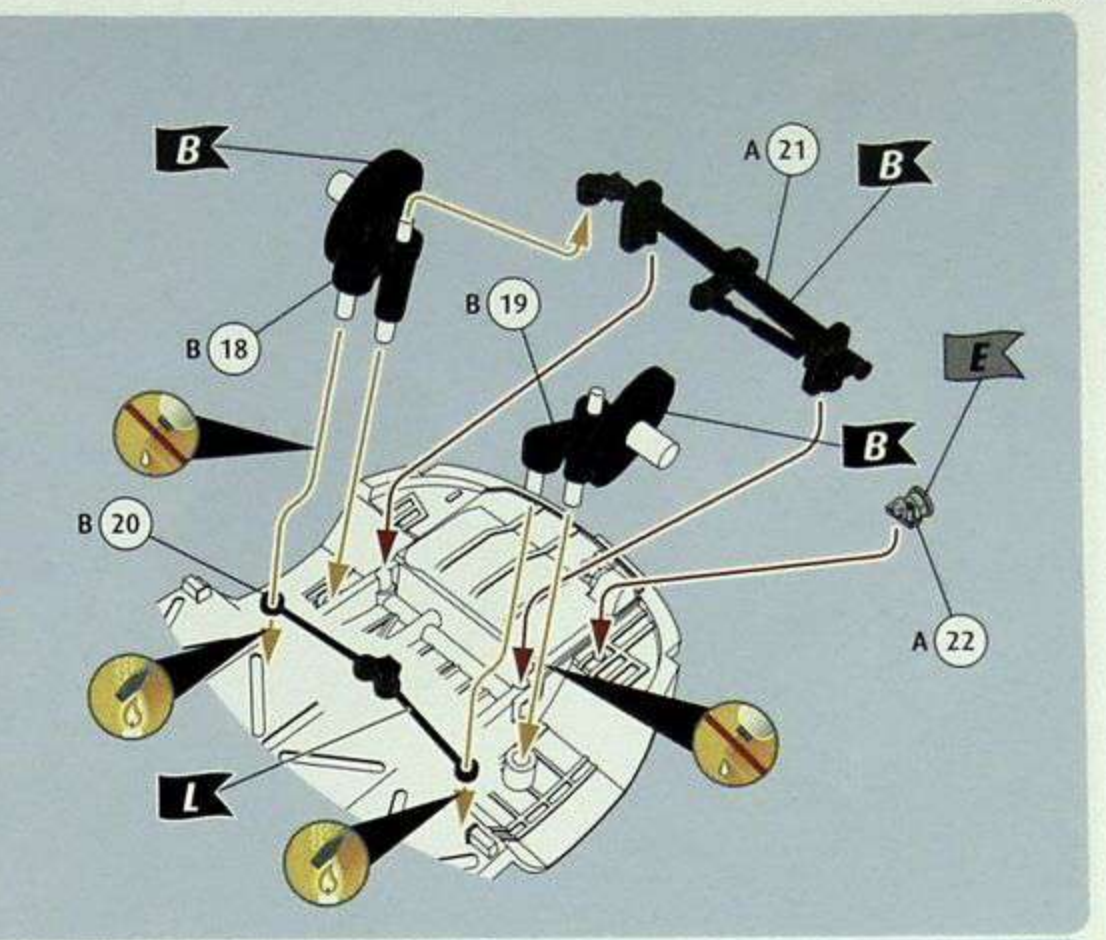
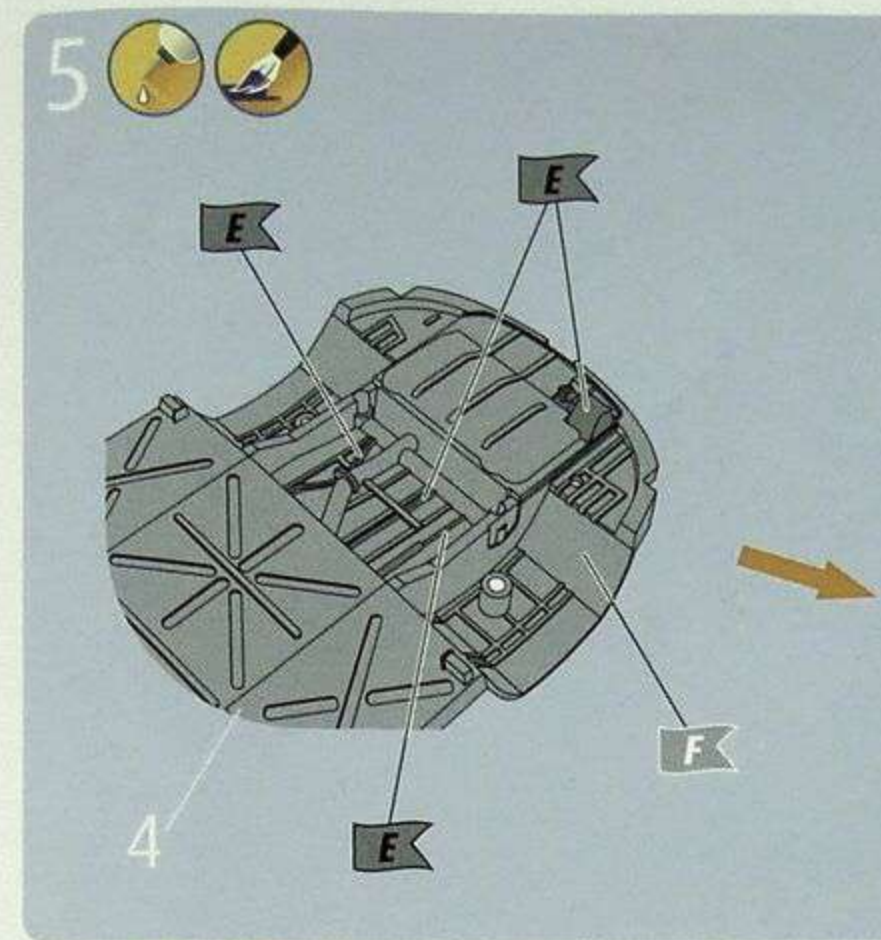
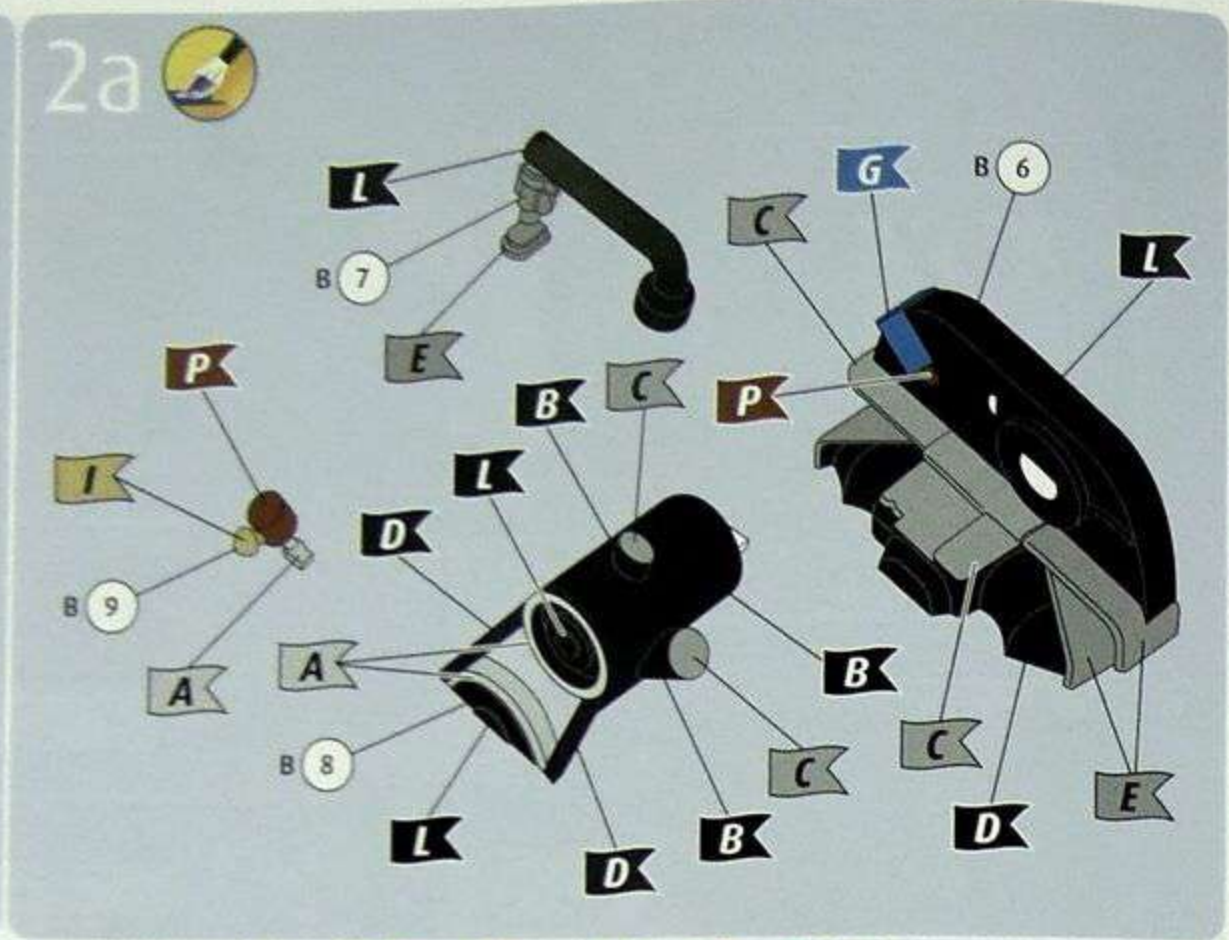
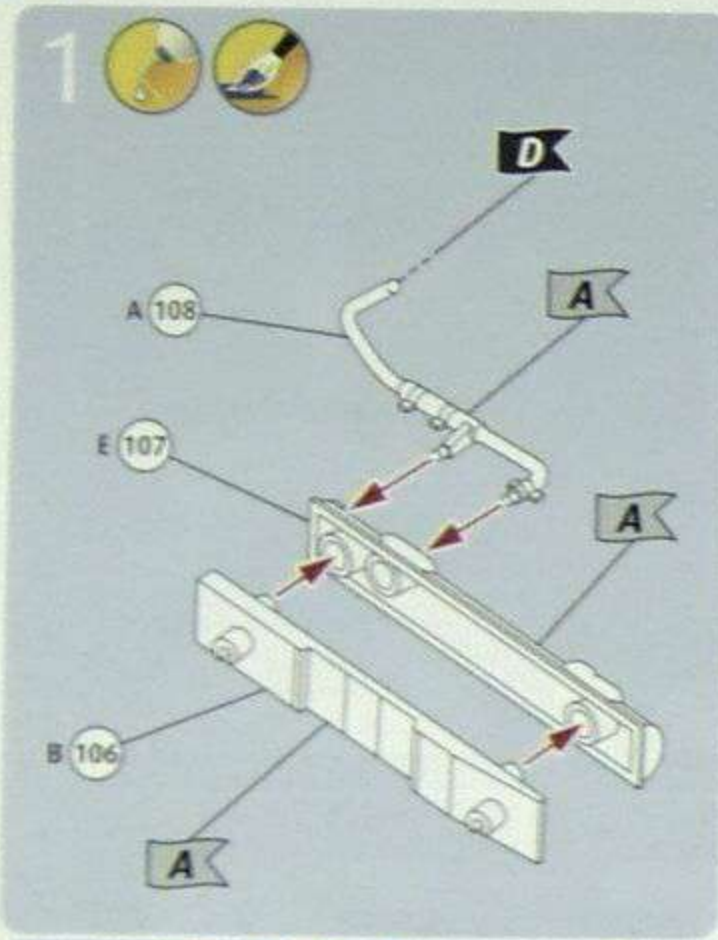

www.mojehobby.pl www.super-hobby.com

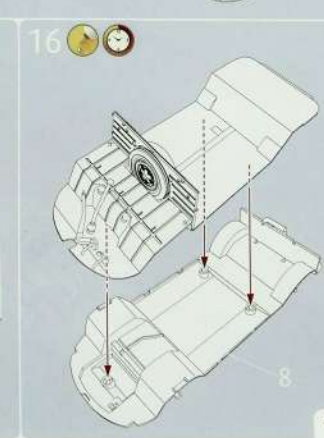
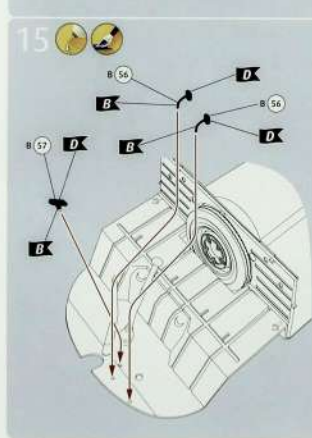
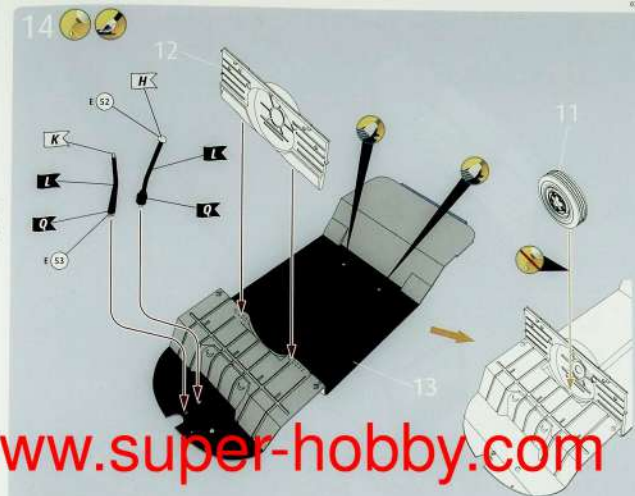
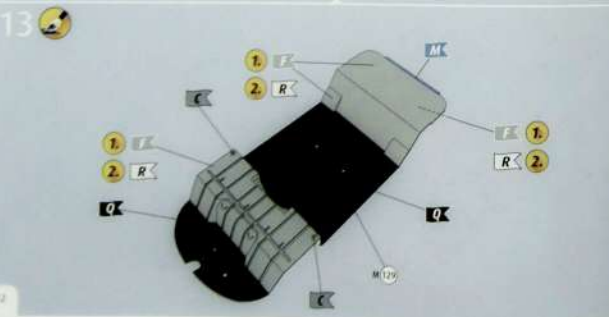
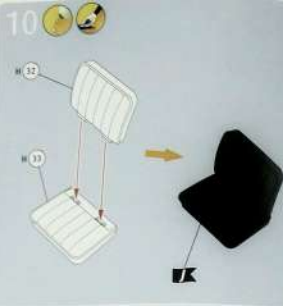
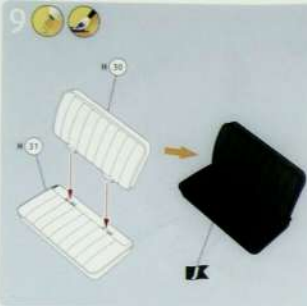

[www.mojehobby.pl](http://www.mojehobby.pl) [www.super-hobby.com](http://www.super-hobby.com)

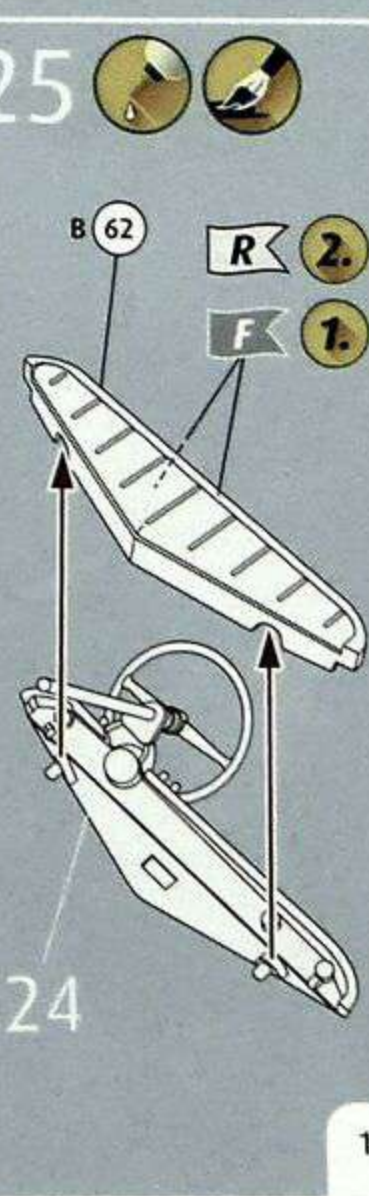
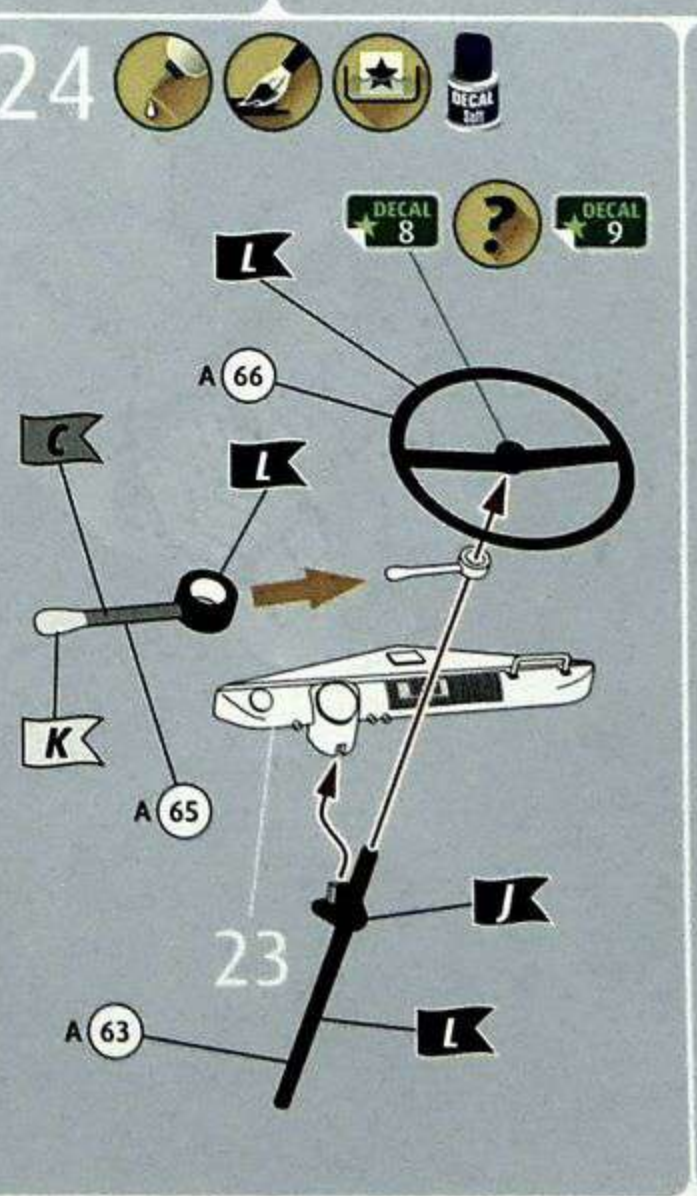
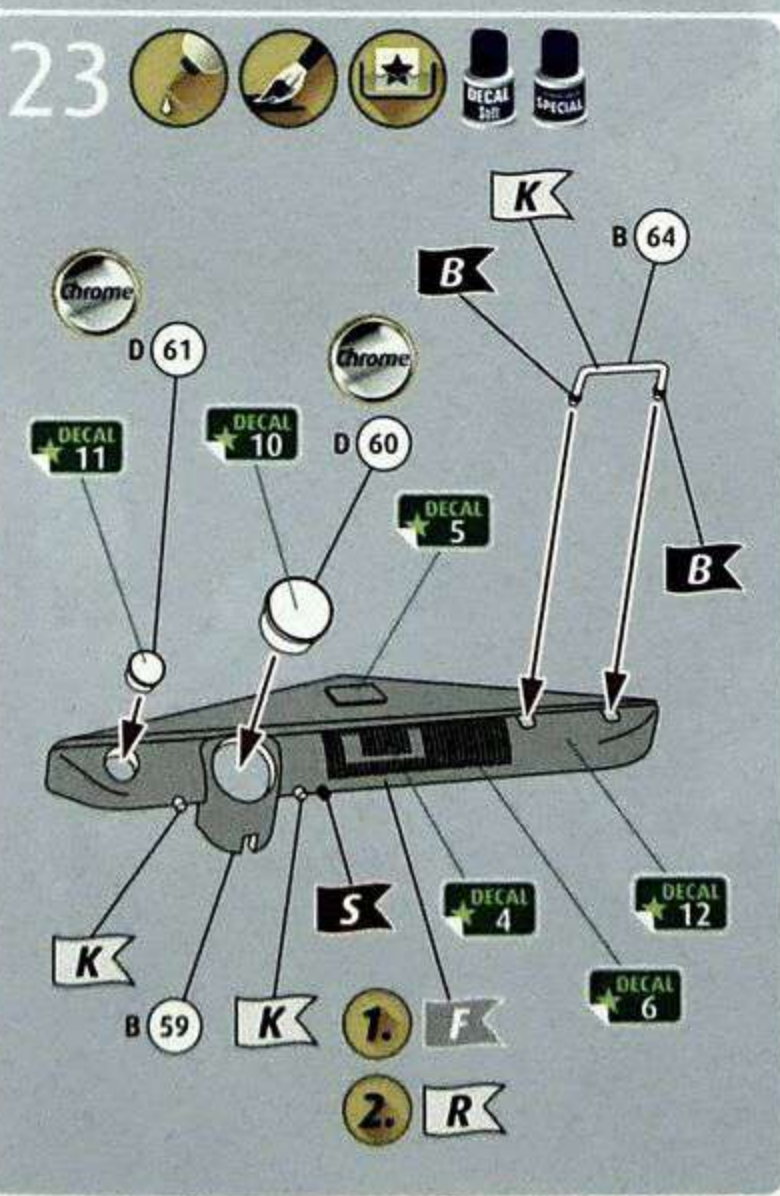
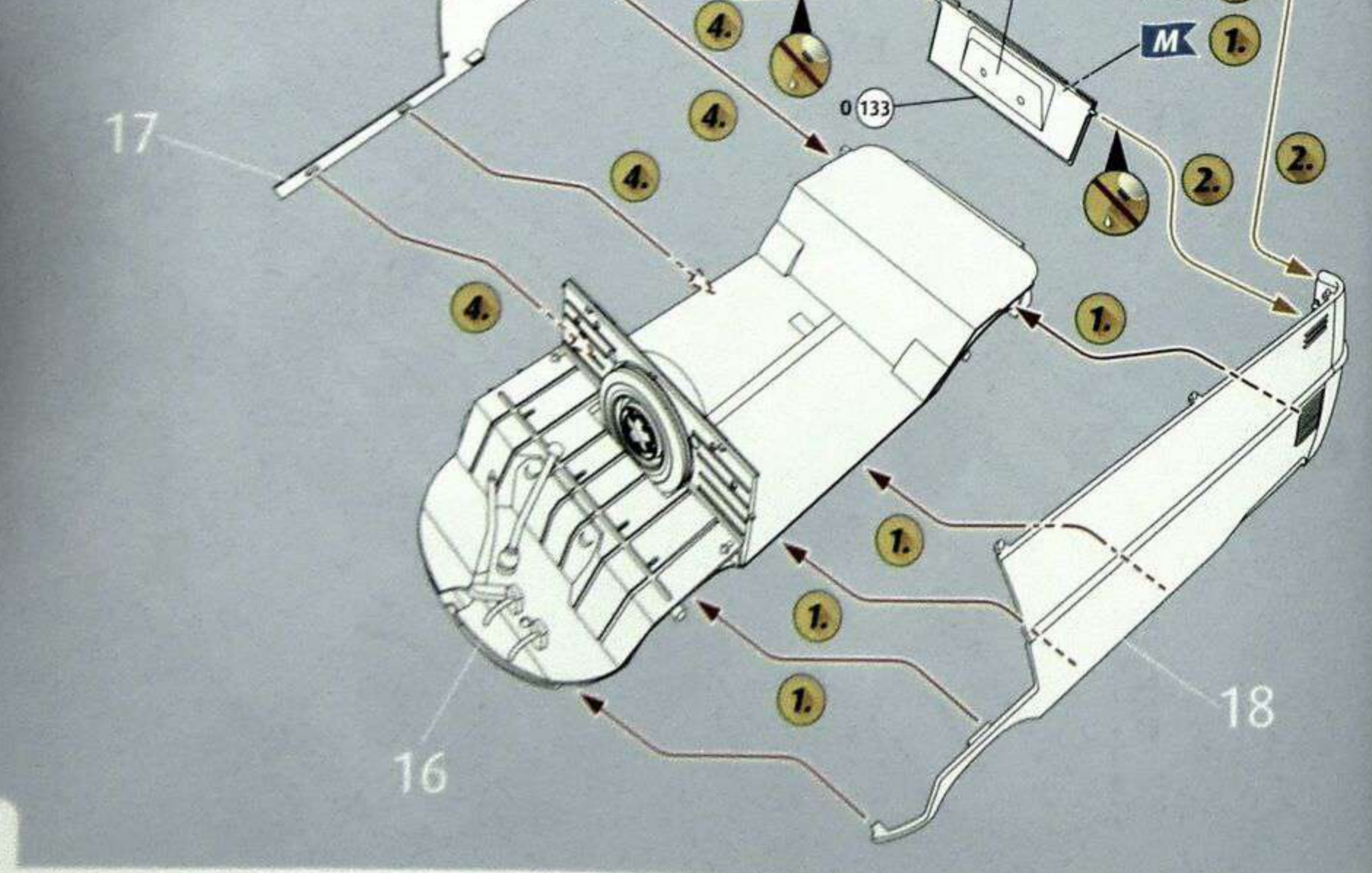
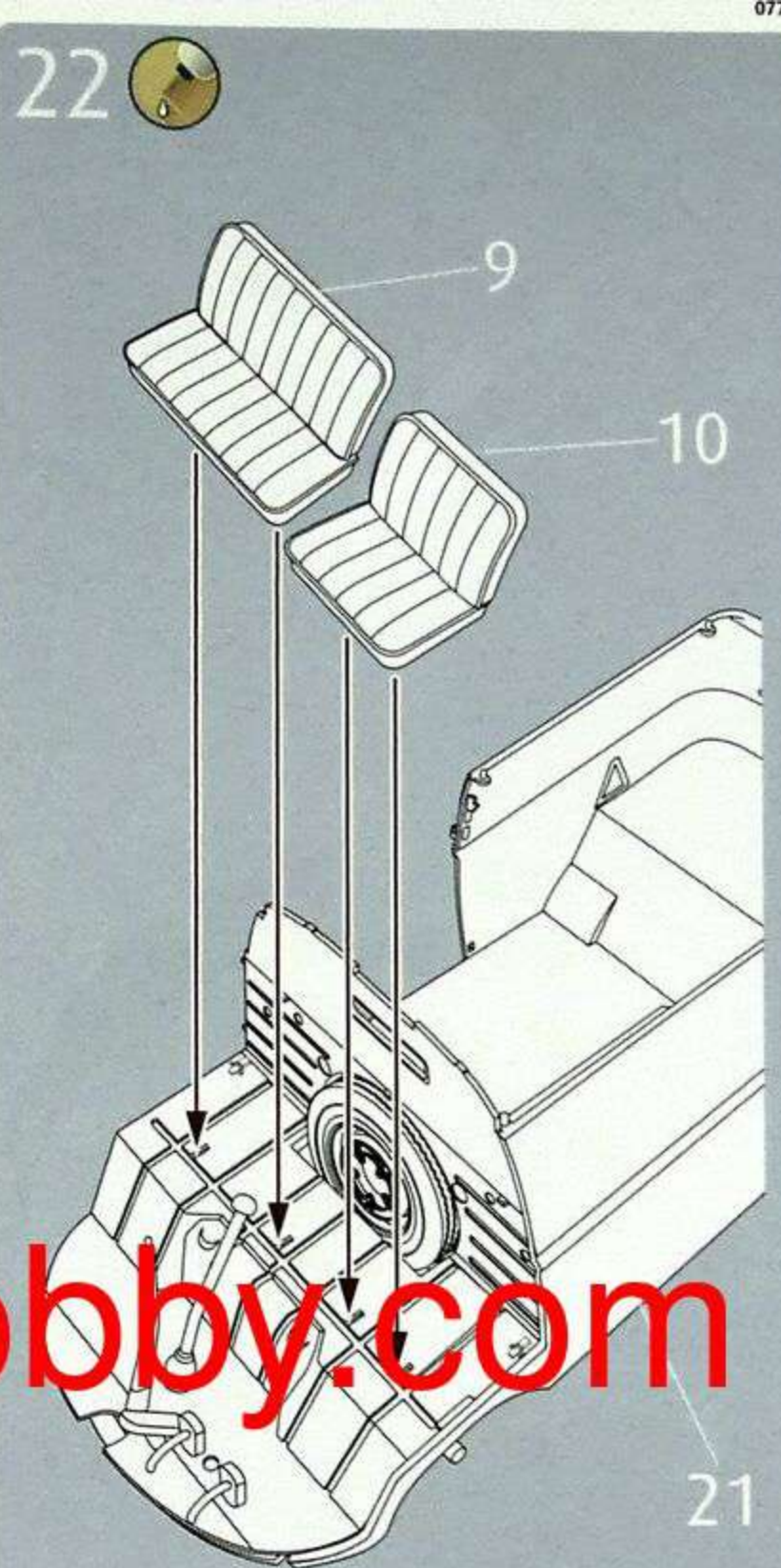
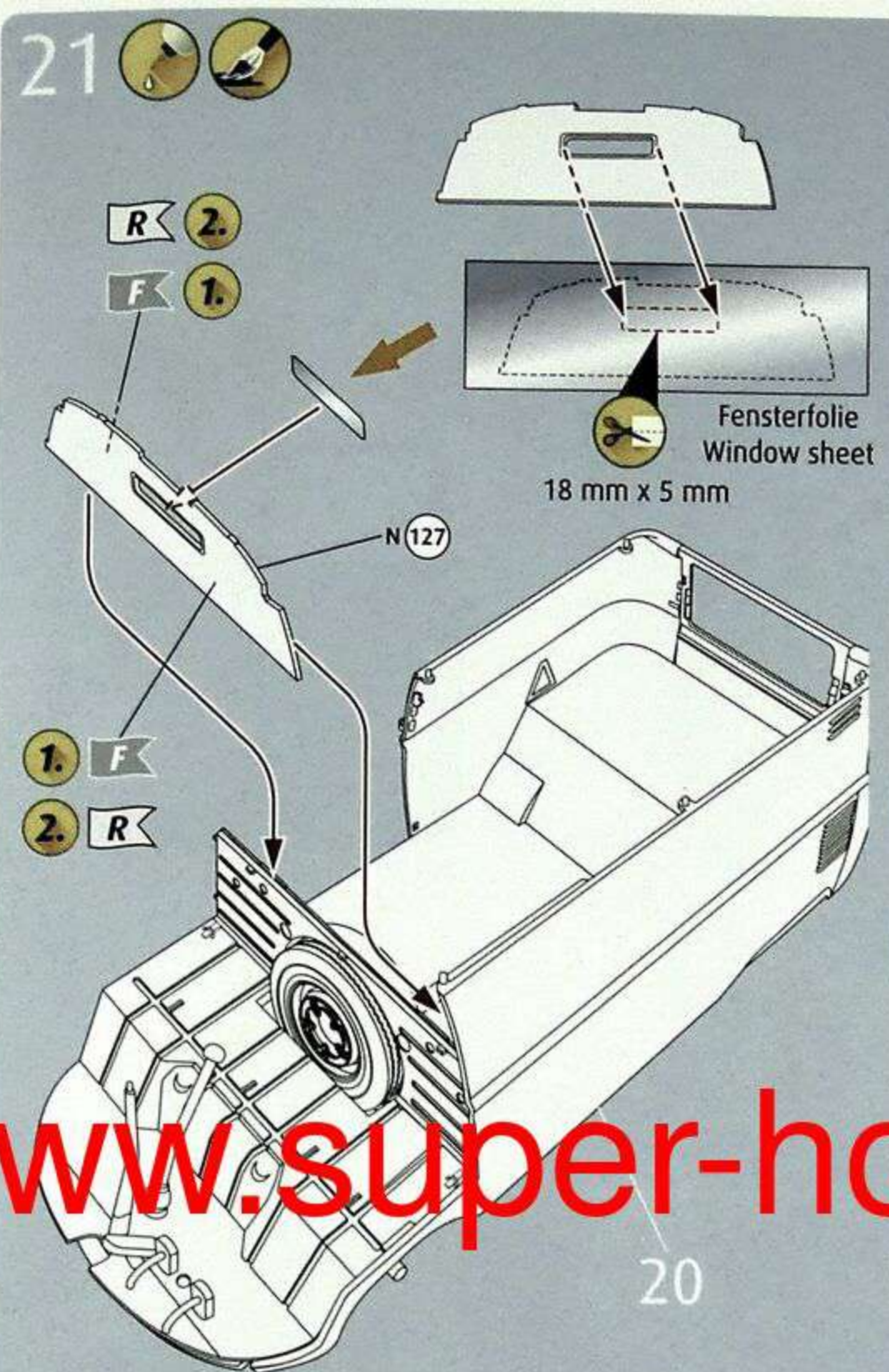
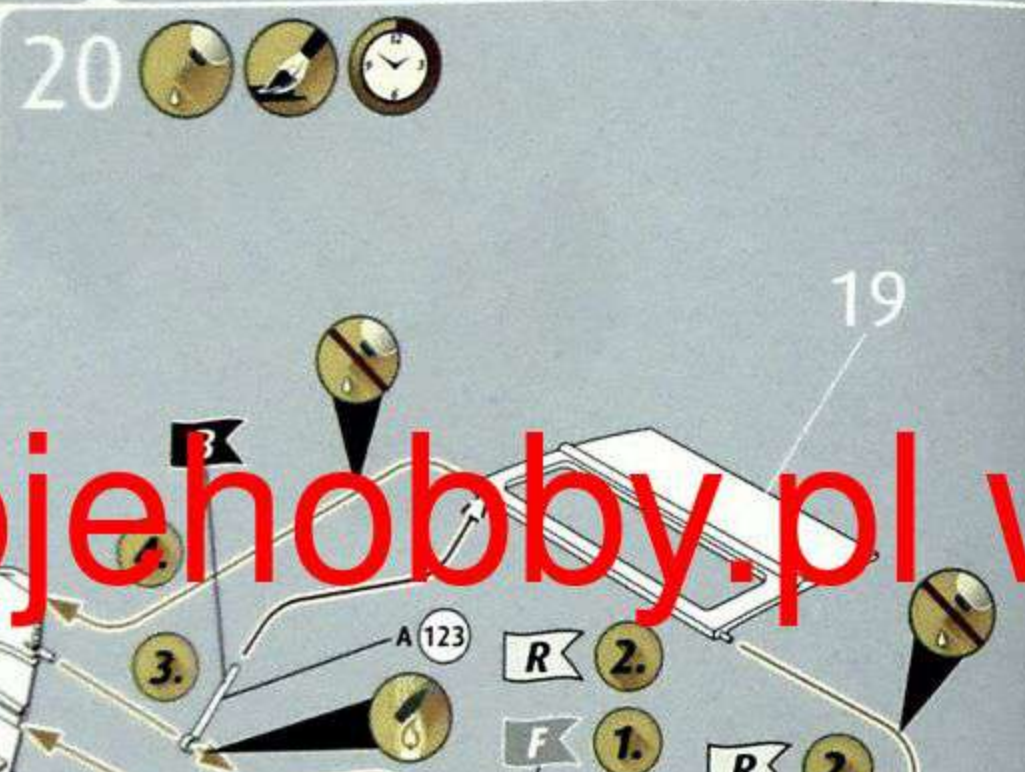
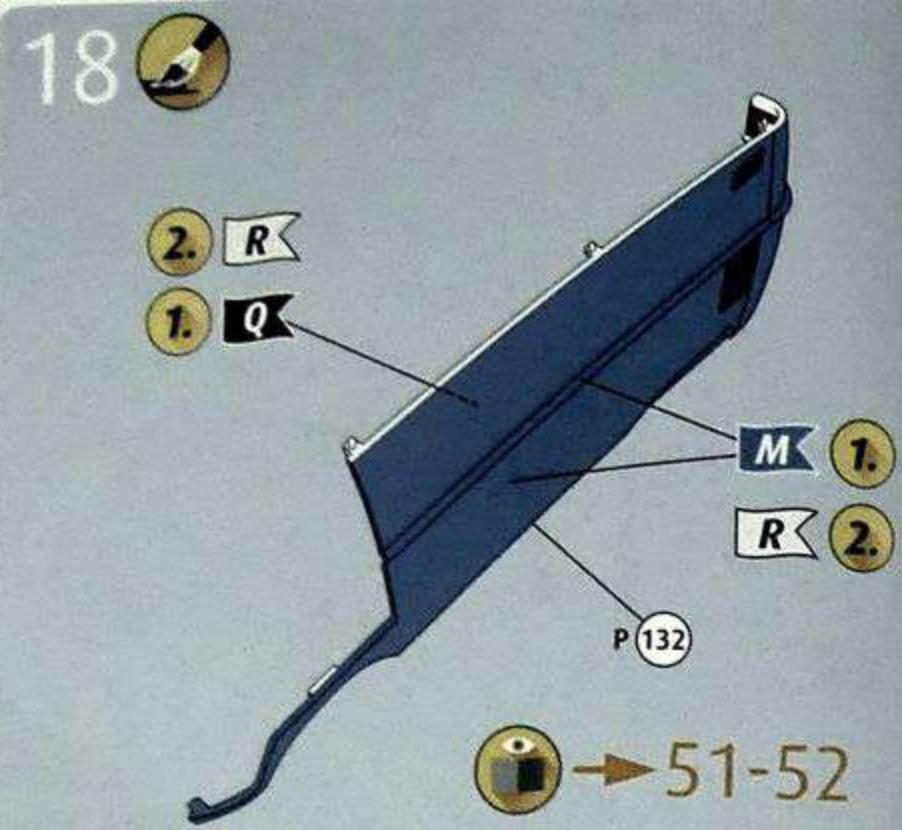
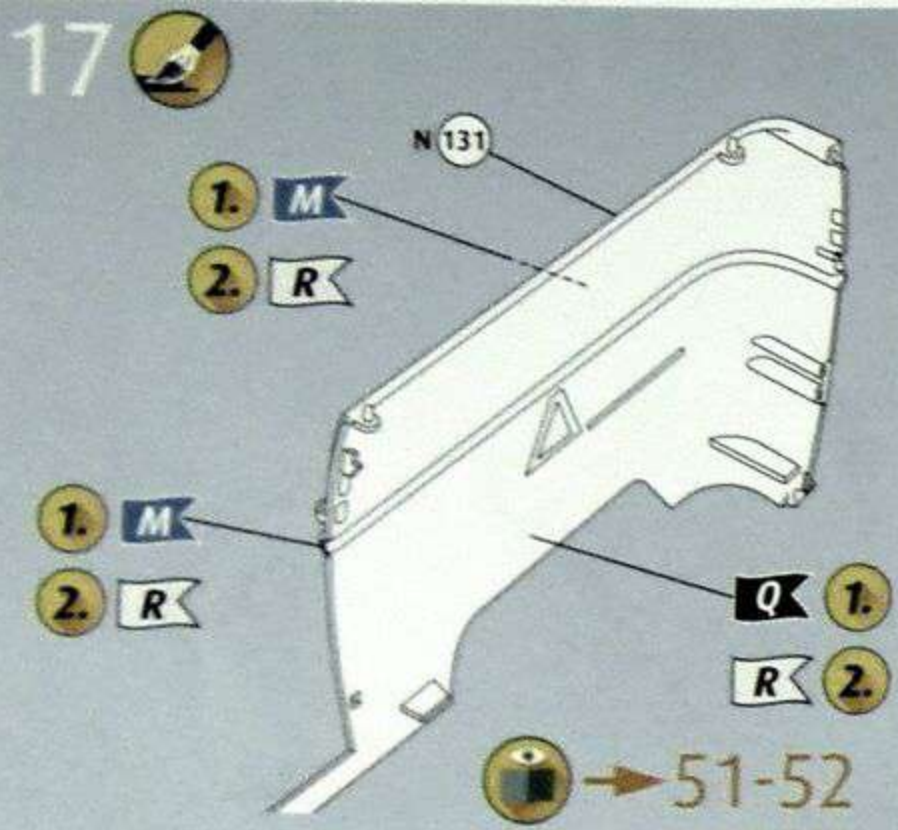

[www.mojehobby.pl](http://www.mojehobby.pl) [www.super-hobby.com](http://www.super-hobby.com)



26

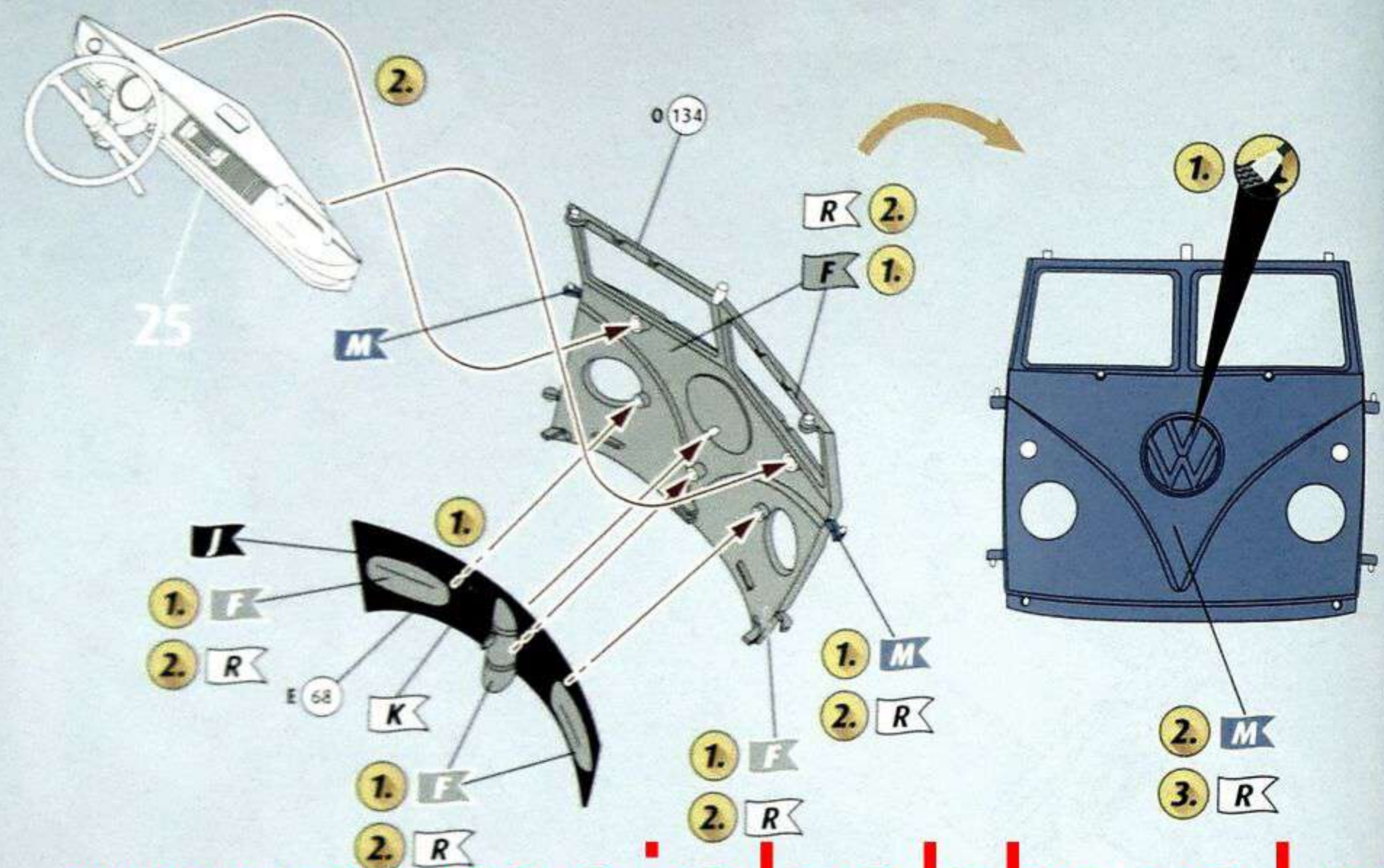

28

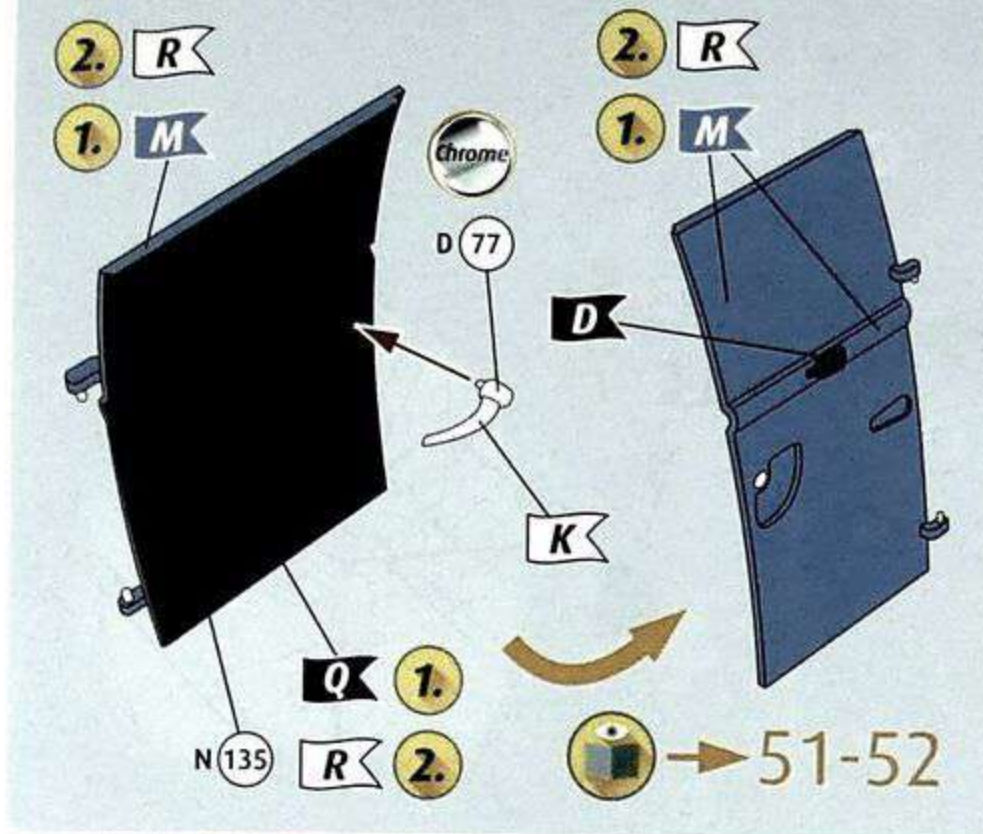

29

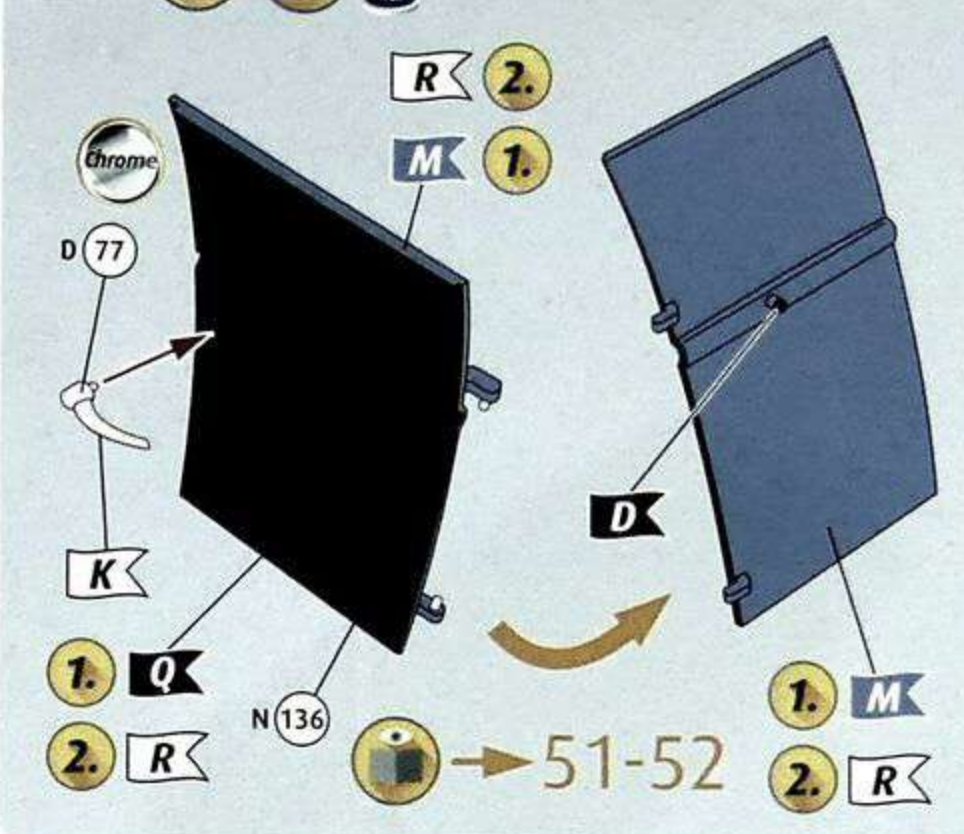

27

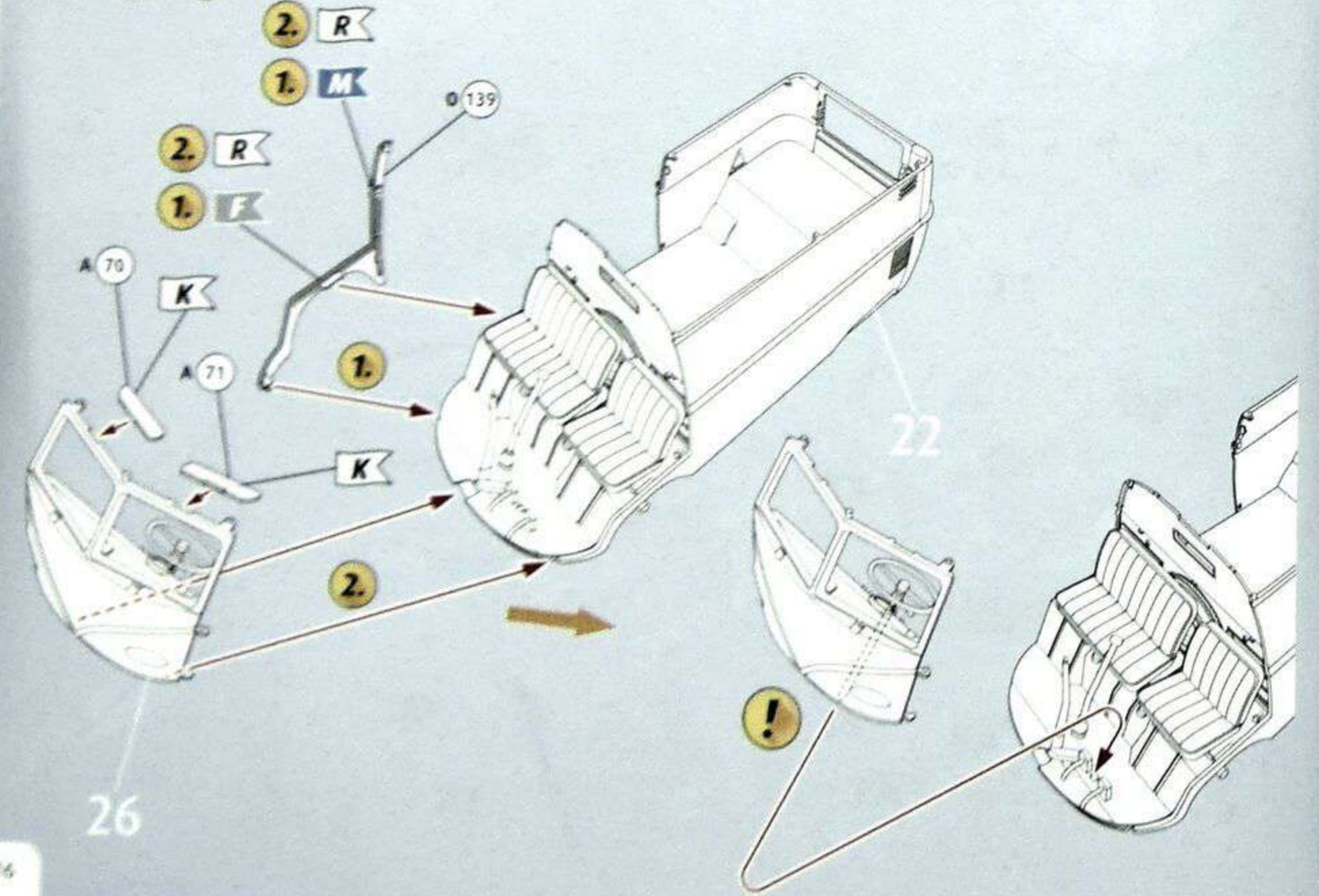

30

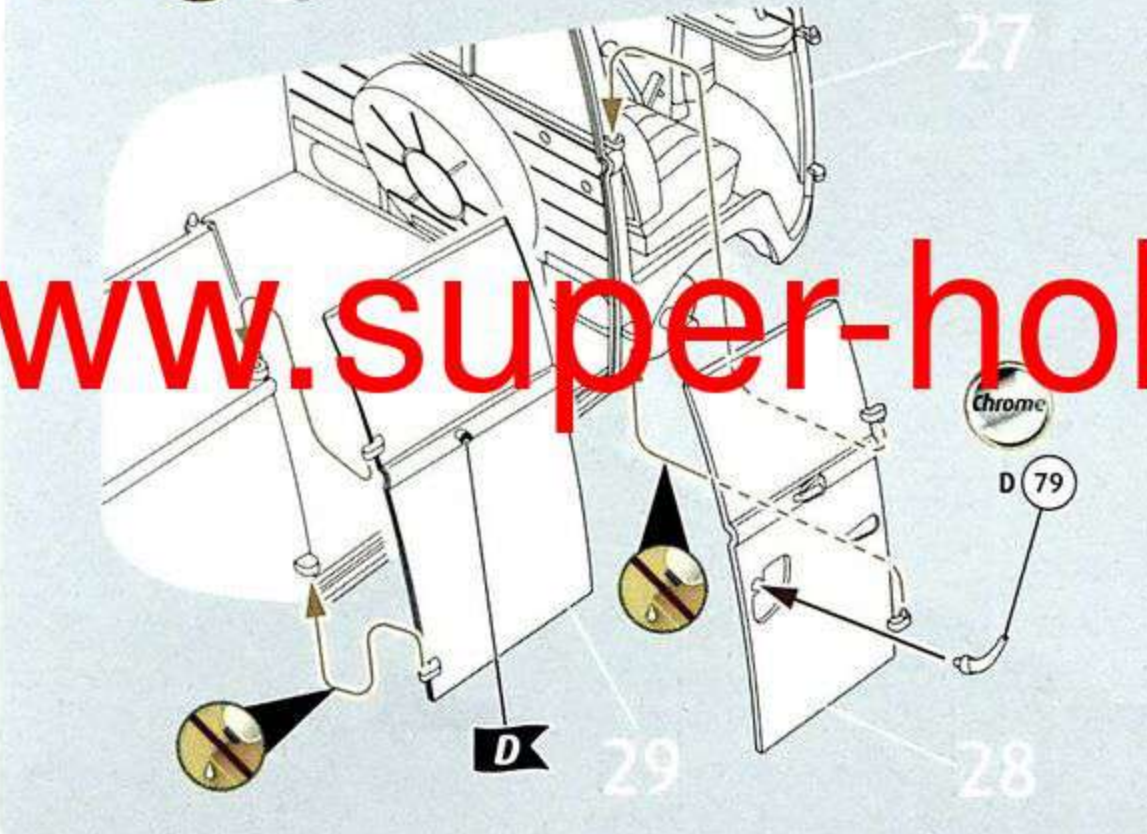

31

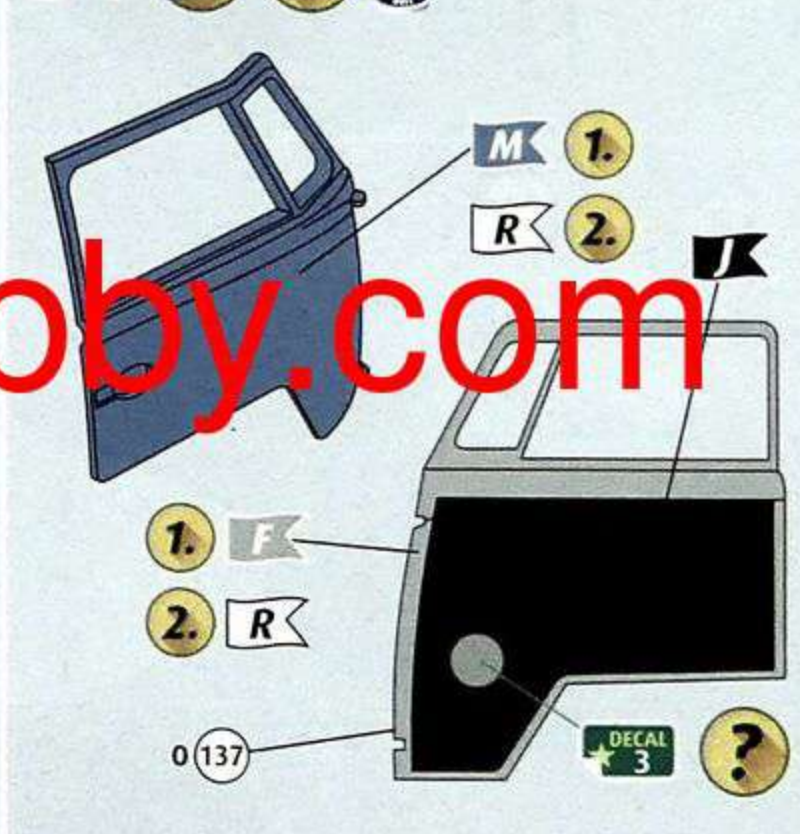

32

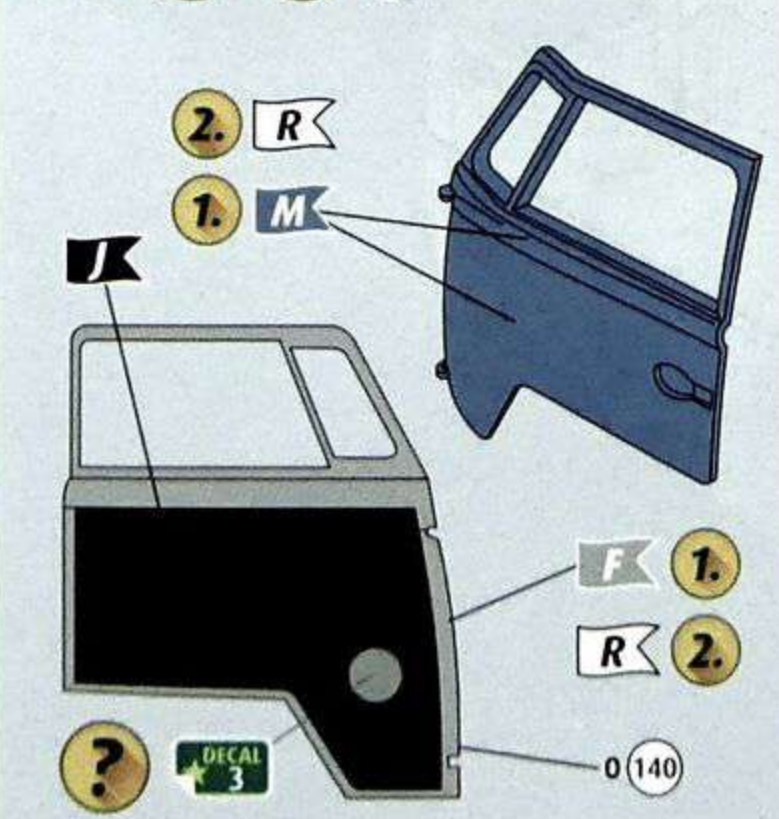

33

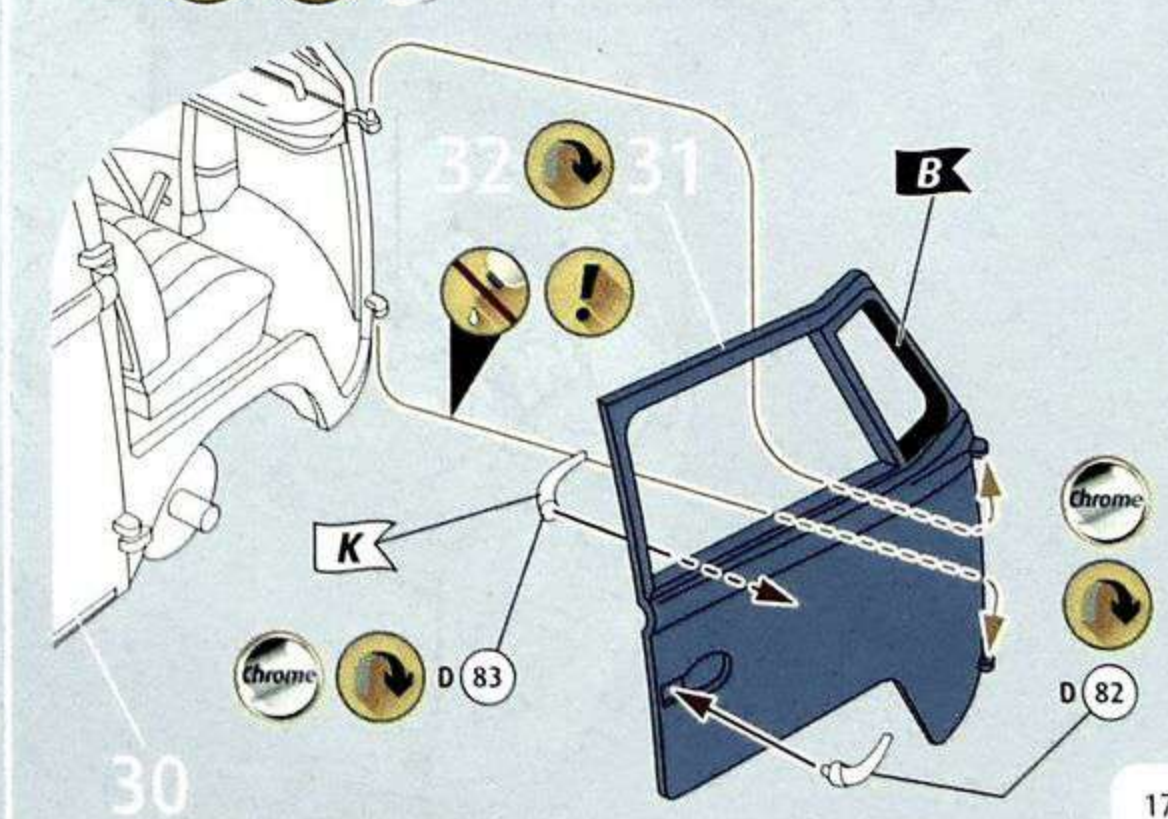

www.mojehobby.pl www.super-hobby.com

34

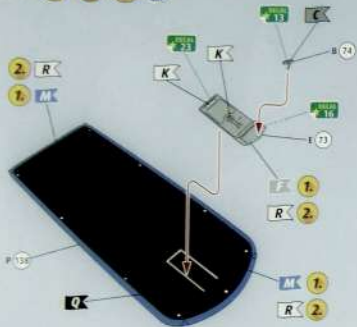

35



37

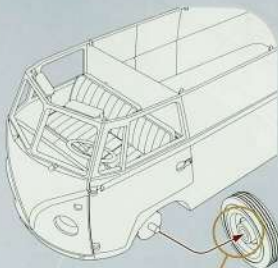

38

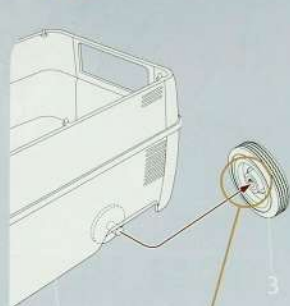

36



39

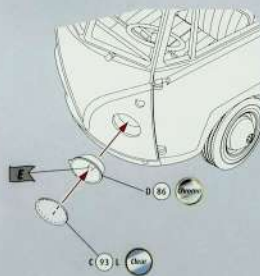

40

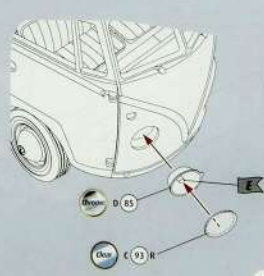

[www.moje hobby.pl](http://www.moje hobby.pl) [www.super-hobby.com](http://www.super-hobby.com)

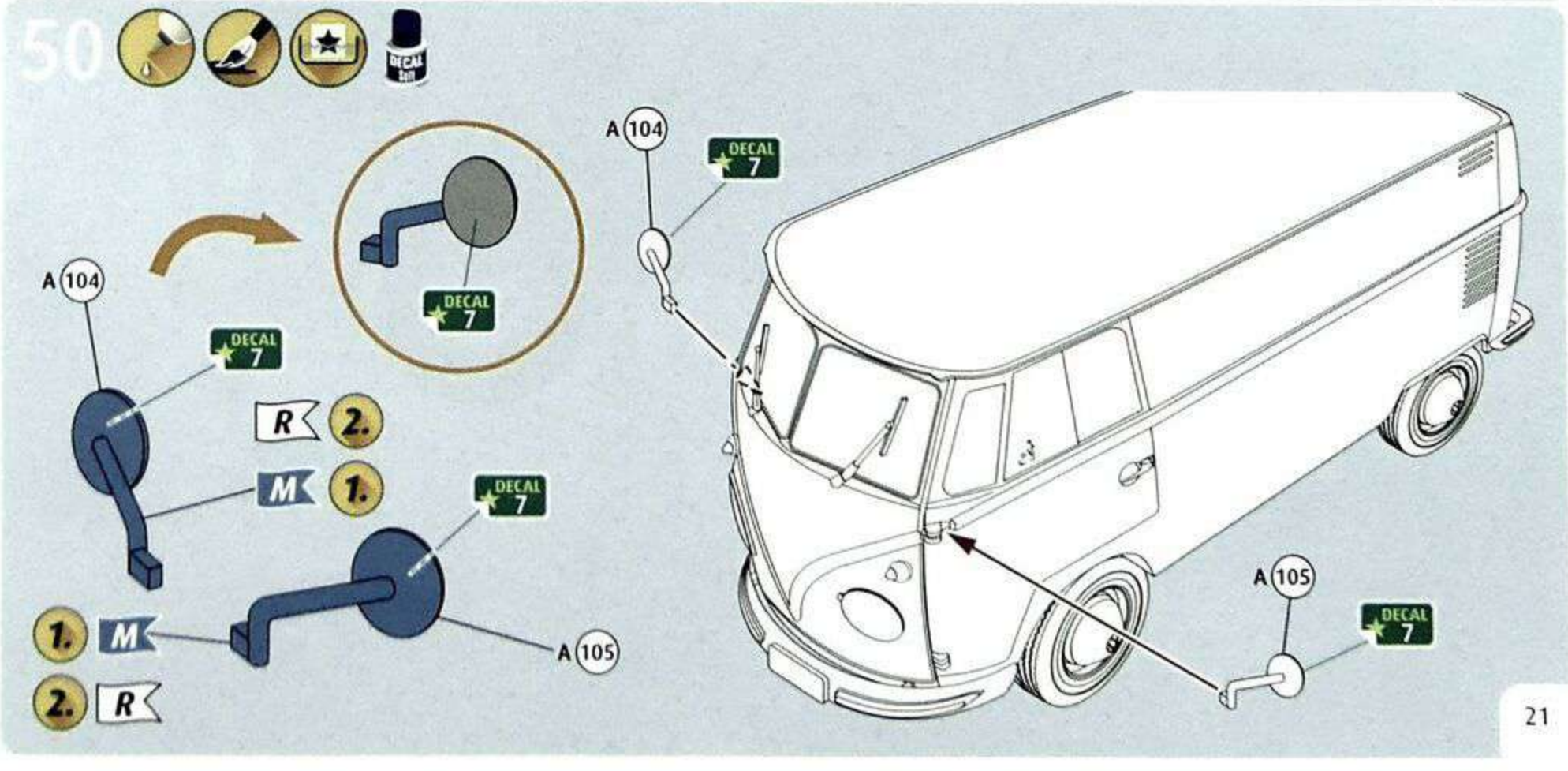
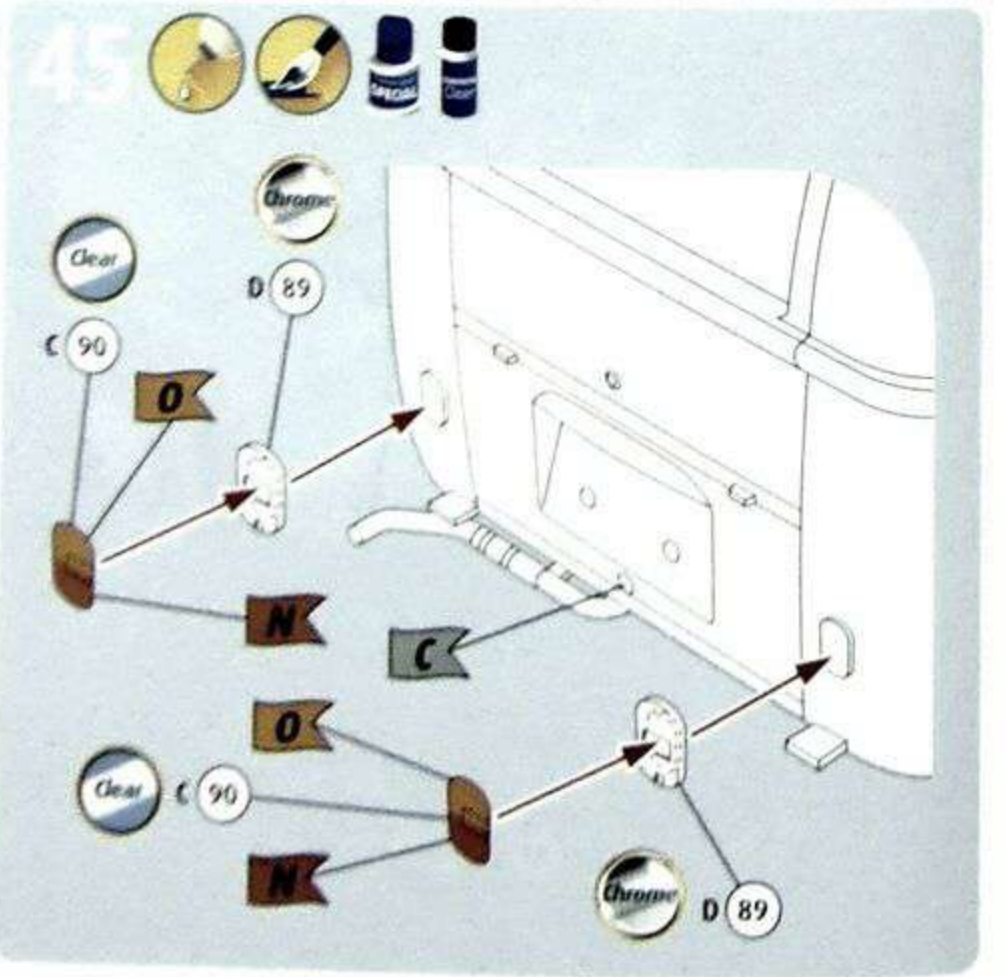
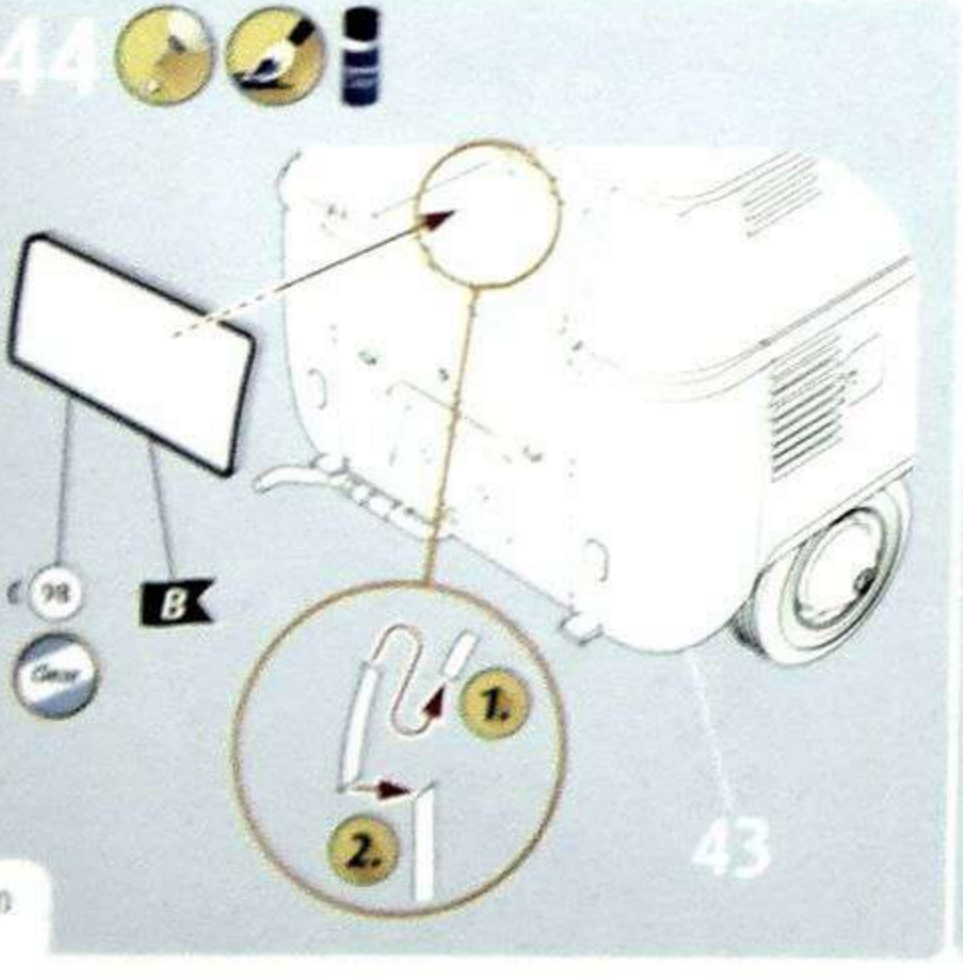
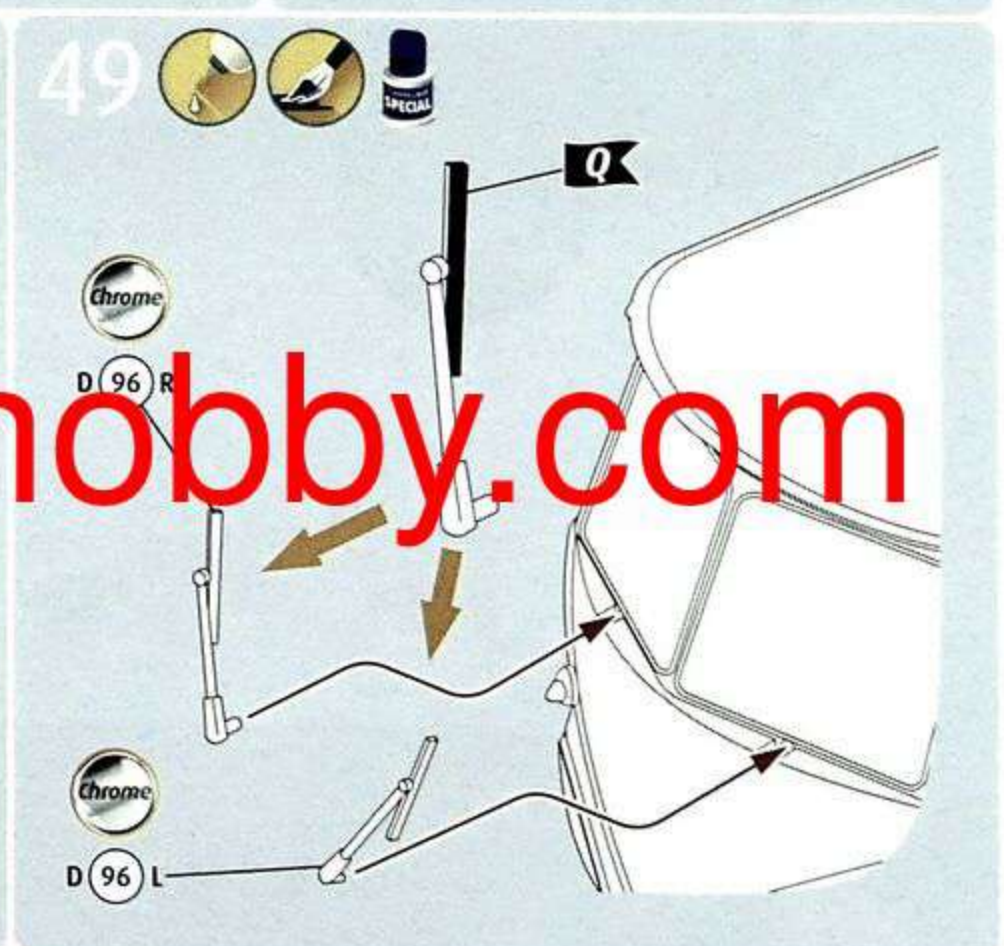
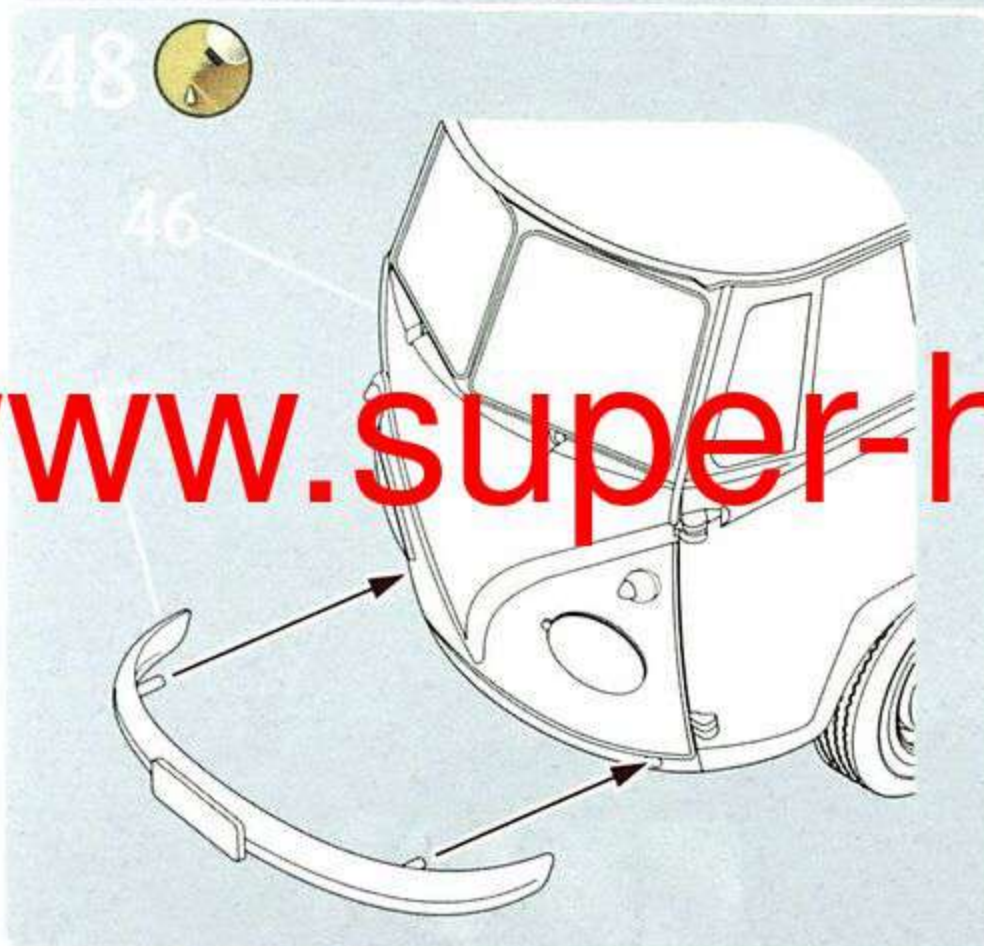
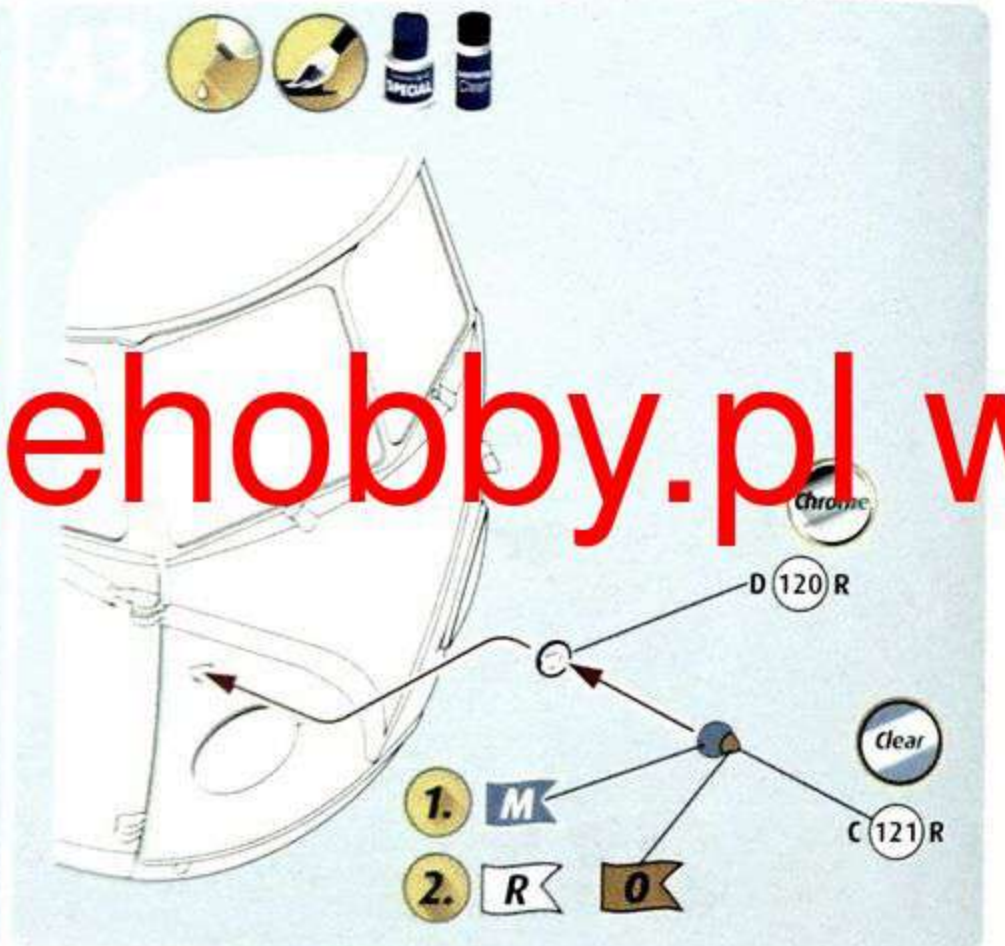
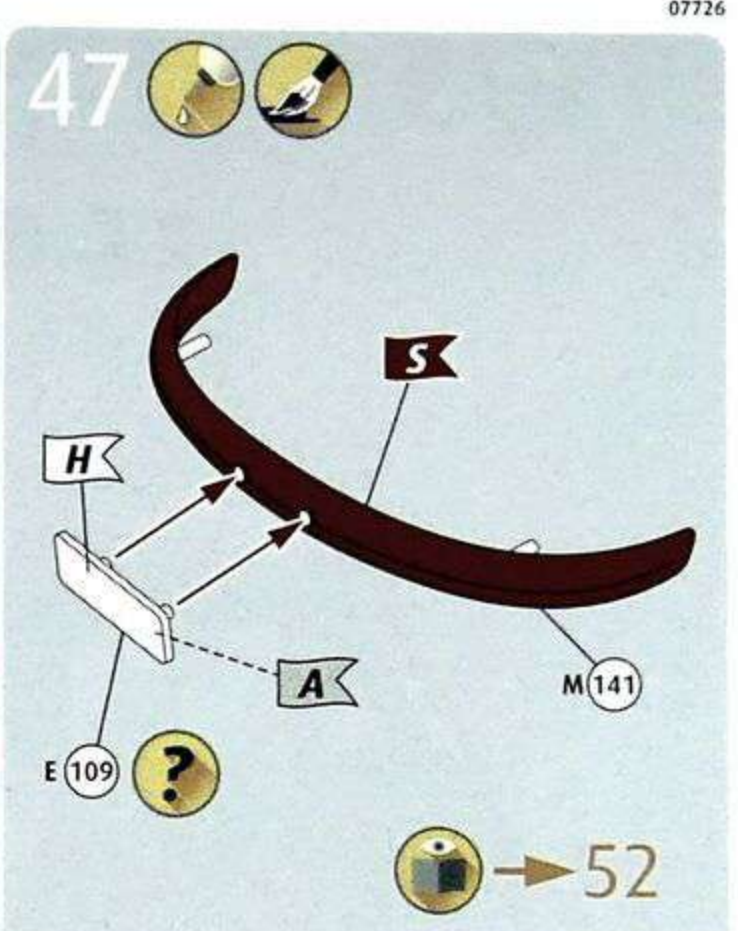
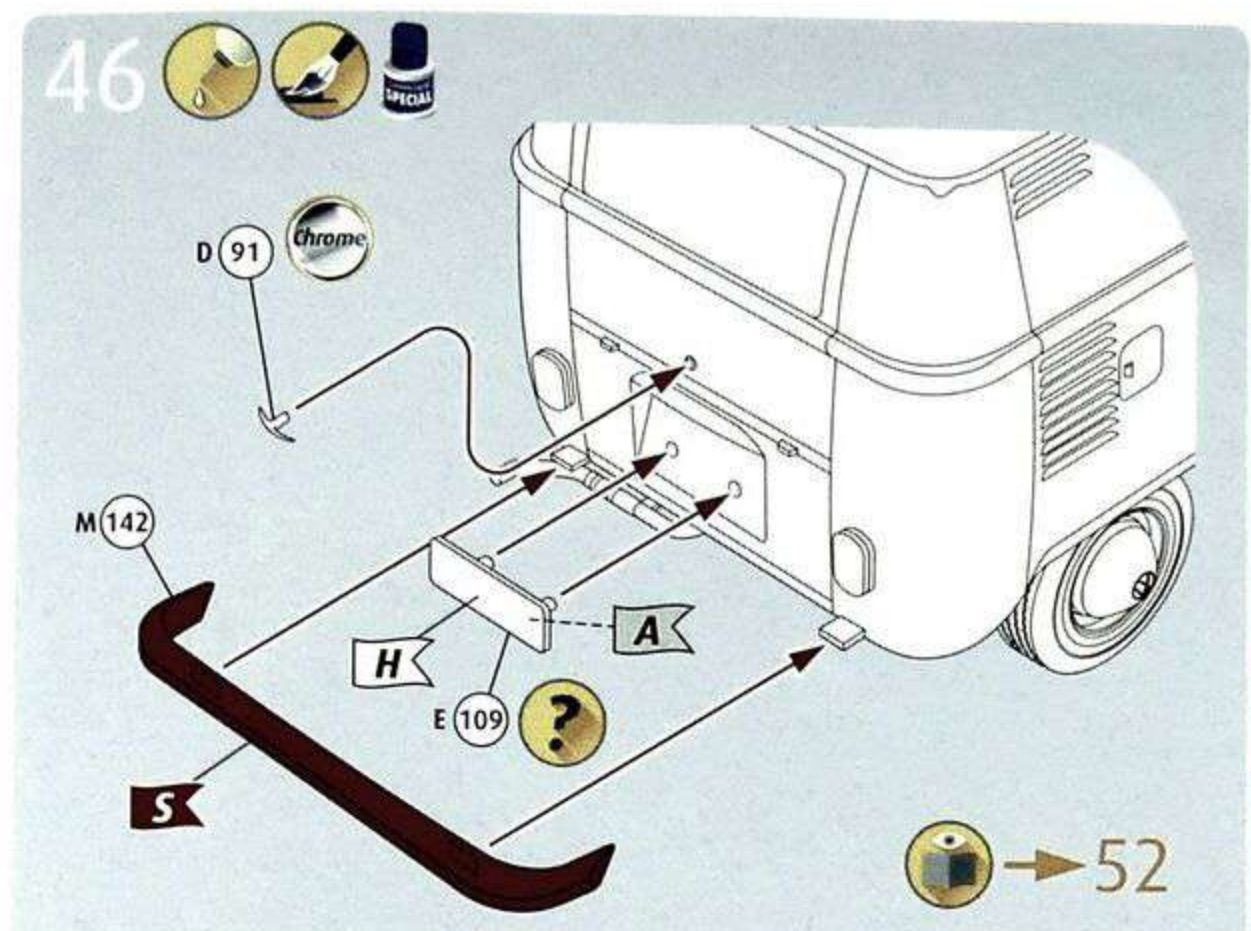
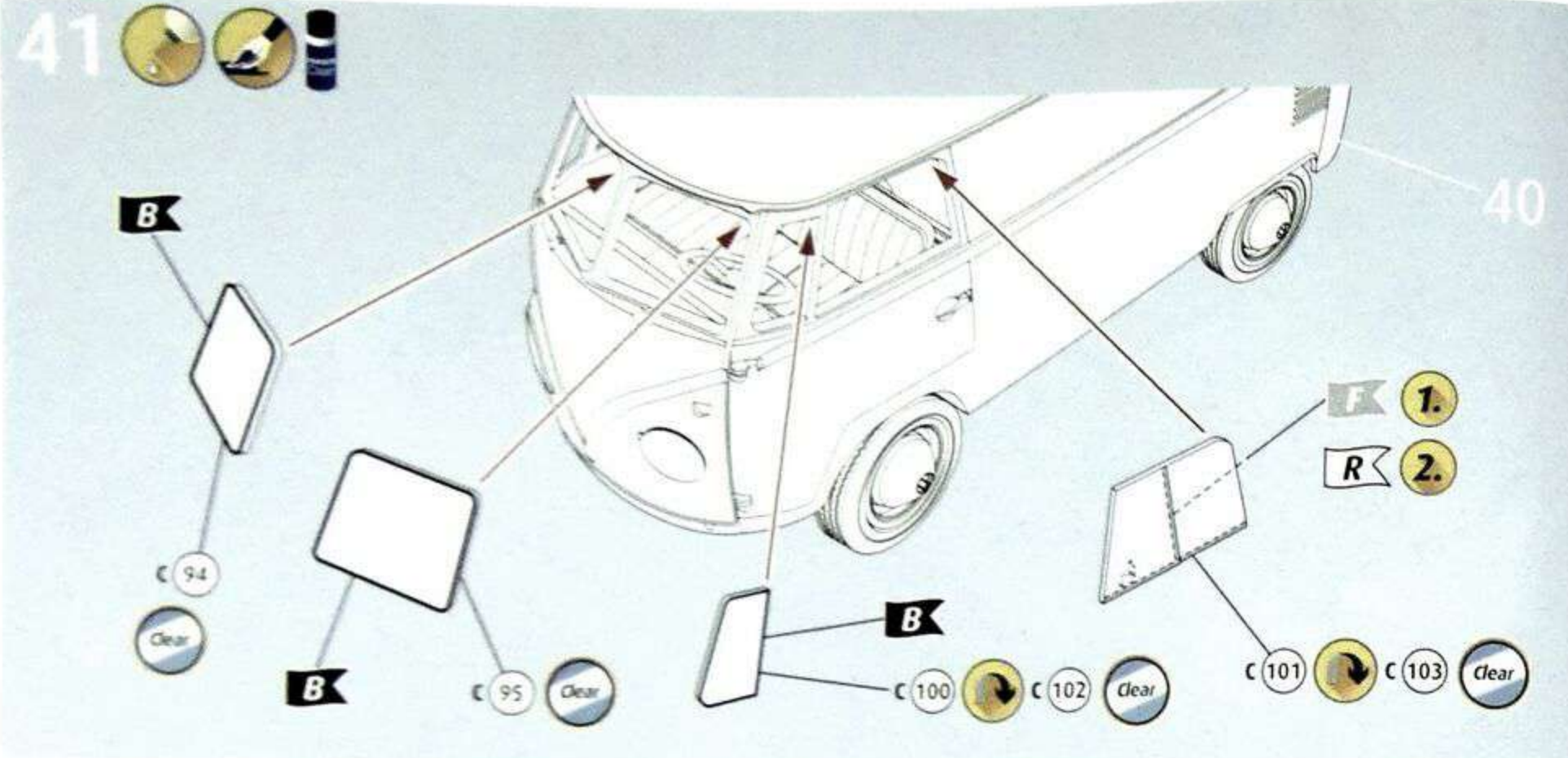

[www.moje hobby.pl](http://www.moje hobby.pl) [www.super-hobby.com](http://www.super-hobby.com)



B M N O S

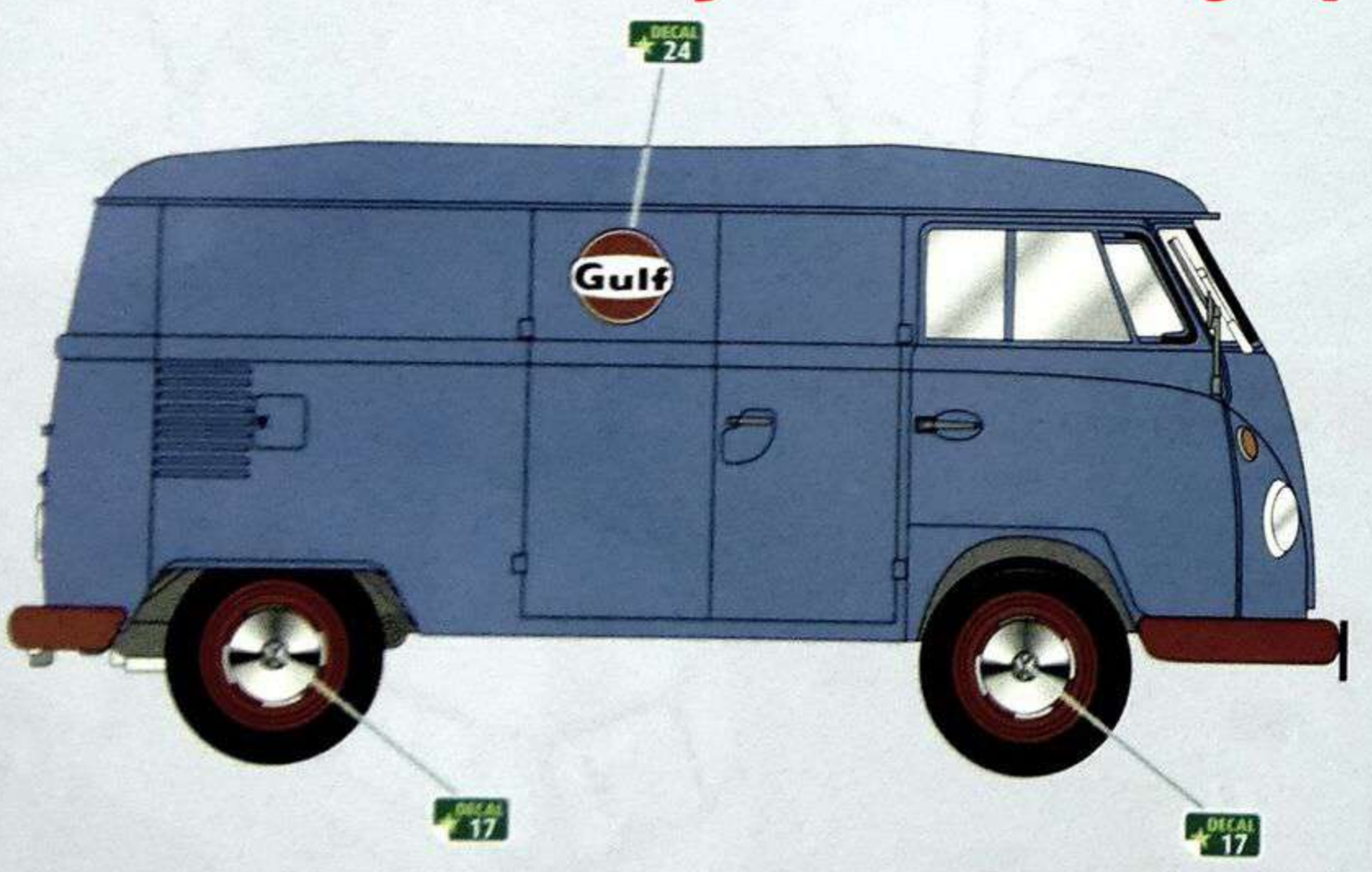
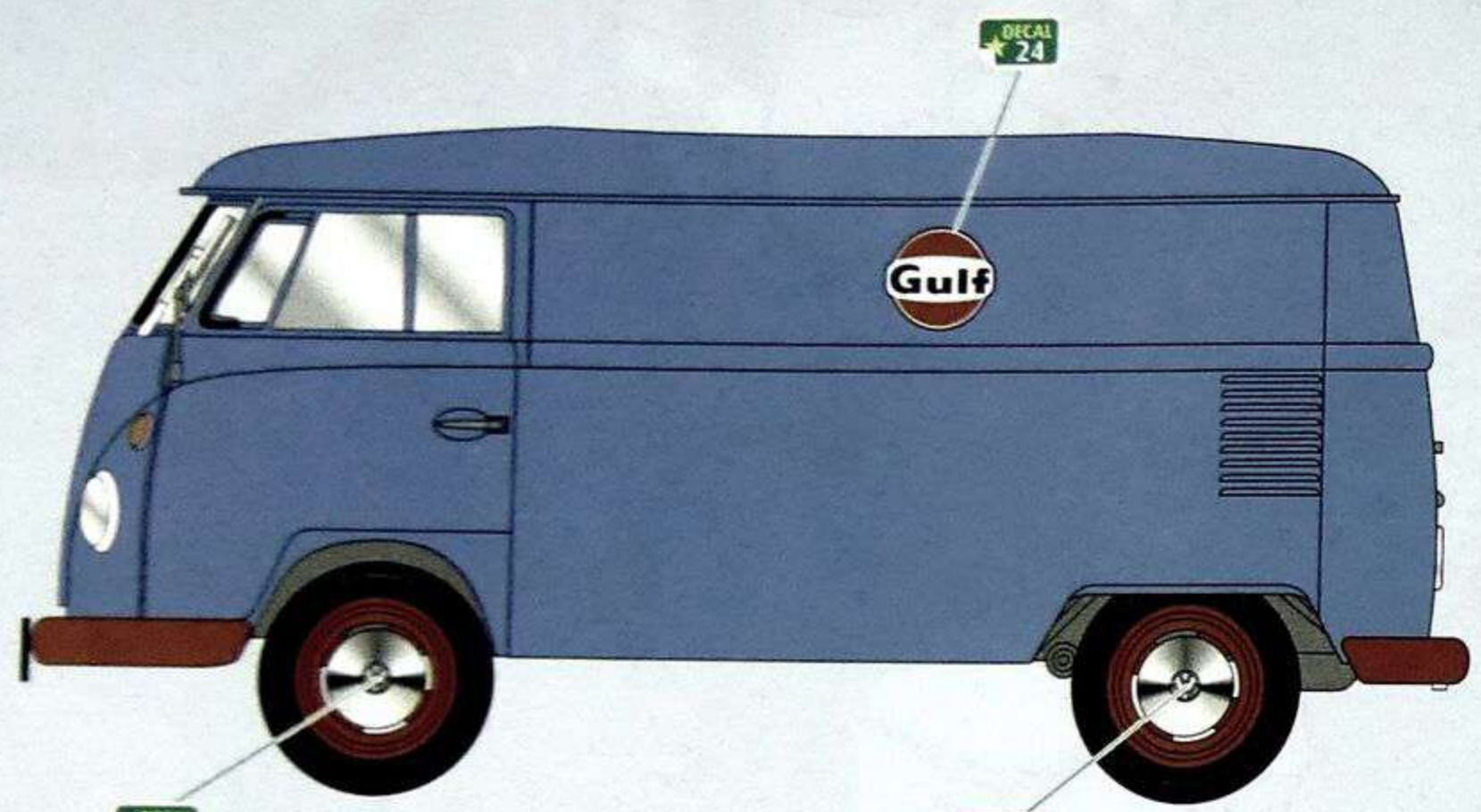

B M N O S

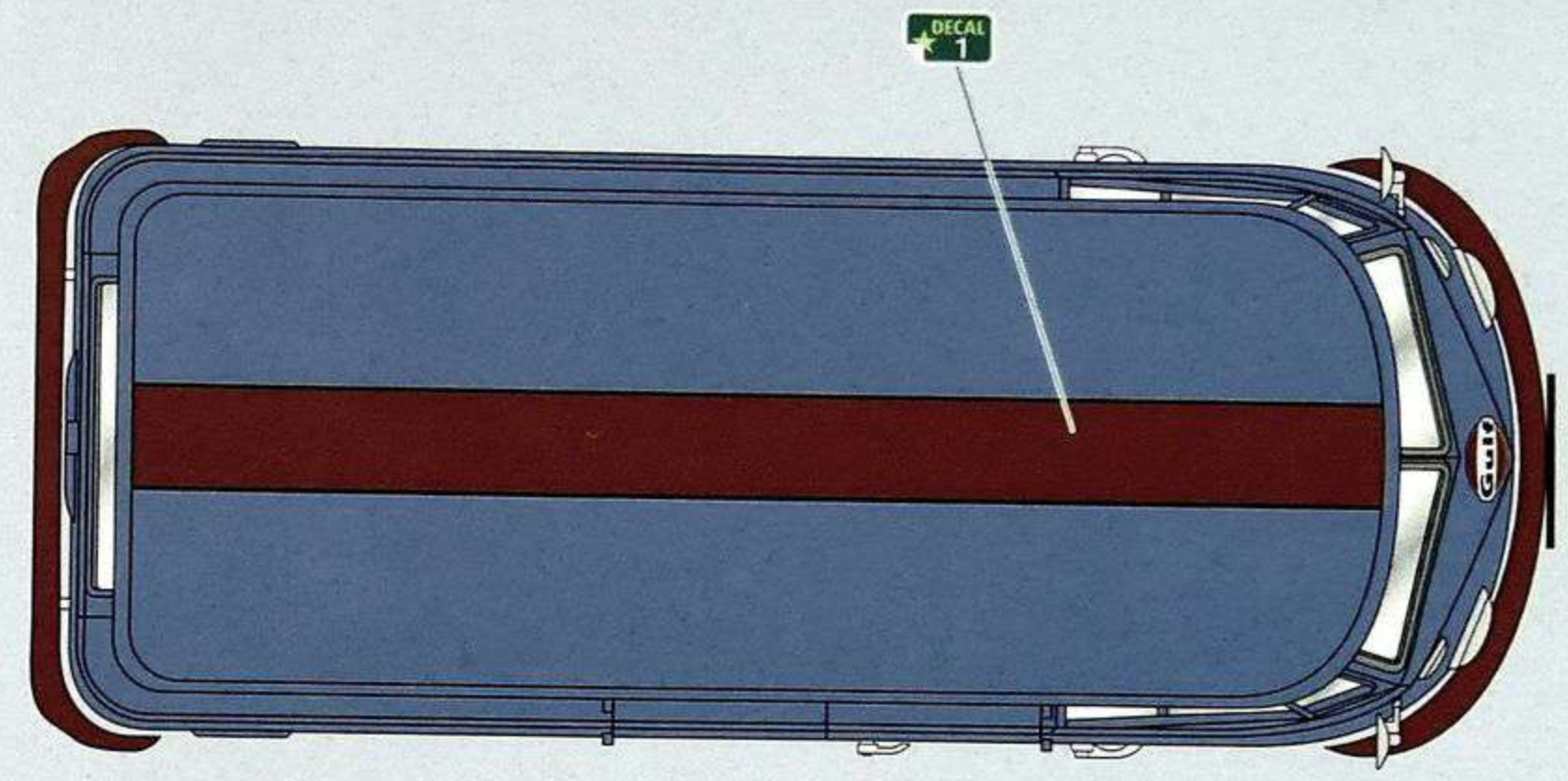

www.moje hobby.pl www.super-hobby.com

